



**zafferano**  
LAMPES-À-PORTER

**zafferano**  
LAMPES-À-PORTER

# E se fosse una lampada a illuminare l'inaspettato?

What if a lamp  
could light up the unexpected?



Questo che vi proponiamo  
è un breve viaggio nella natura  
natura protagonista con la sua intatta bellezza.  
Lampade che fanno da contrappunto a questi paesaggi  
accoglienti e disponibili  
offrono luoghi inaspettati, inconsueti  
dove la luce, compagna fedele,  
fa riscoprire colori e profili  
che i tramonti vanno via via dileguando  
inghiottiti dall'oscurità.

What we propose  
is a short journey into nature.  
With its unspoilt beauty, nature is the protagonist.  
Lamps bring a contrast to these  
welcoming and receptive landscapes.  
They offer unexpected and unusual places,  
where light, a faithful companion,  
lets you rediscover colours and profiles  
that sunsets gradually fade away  
swallowed by darkness.

# Indice delle collezioni

## Collections overview

06	12	20	24	30	34	38	42
<b>Poldina</b>	Tavolo Table lamp	Mini tavolo Mini table lamp	Micro tavolo Micro table lamp	L desk tavolo L desk table lamp	L terra-tavolo L floor-table lamp	XXL terra-tavolo XXL floor-table lamp	Picchetto Lamp with peg

46	50	54	58	60	70	74
<b>Poldina</b>	Sospensione Suspension lamp	Parete Wall lamp	Cover Cover	<b>Poldina Reverso</b> Tavolo Table lamp	<b>Ofelia</b> Tavolo Table lamp	

78	82	86	90	94	98	102
<b>Olivia</b>	Tavolo Table lamp	Mini tavolo Mini table lamp	<b>Pina</b>	Tavolo Table lamp	Supporto da terra Floor stand	Vassoio Tray

106	108	114	120	126	128	130
<b>Swap</b>	Tavolo Table lamp	Paralumi Lampshades	Mini tavolo Mini table lamp	Paralumi Lampshades	<b>Push-up</b>	Tavolo Table lamp

134	136	140	142	144	148	150
<b>Home</b>	Tavolo Table lamp	Supporto parete Wall lamp kit	<b>Dama</b>	Tavolo Table lamp	<b>Olimpia</b>	Tavolo Table lamp

154	158	162	166	170
<b>Sister Light</b>	Tavolo Table lamp	Mini tavolo Mini table lamp	Picchetto Lamp with peg	Parete Wall lamp

174	178	184	188	190	192	194	196
<b>Pencil</b>	Modulo luminoso con accessori Lighting module with accessories						

198	198	200	202	204	206	207
<b>Accessori</b> Accessories	Basi di ricarica e caricatori Charging bases and chargers	Basi di ricarica multipla Multi-contact charging base	Batterie Battery packs	<b>Personalizzazioni</b> Customization	<b>Espositore</b> Display unit	<b>Indice per codice</b> Code index



# Poldina

Sembri nata dalle terre umide  
mentre la vicina laguna  
risplende del finire del sole.  
Piccola, illumini  
in un contrasto concreto e voluto  
gli arbusti selvaggi e profumati.

You appear to have come from the wetlands  
while the nearby lagoon  
glows in the setting sun.  
Little one, you illuminate  
with a distinct, intentional contrast  
wild and fragrant shrubs.

TAVOLO / MINI TAVOLO / MICRO TAVOLO / L DESK TAVOLO / L TERRA-TAVOLO / XXL TERRA-TAVOLO / PICCHETTO / SOSPENSIONE /  
PARETE / ACCESSORI  
TABLE LAMP / MINI TABLE LAMP / MICRO TABLE LAMP / L DESK TABLE LAMP / L FLOOR-TABLE LAMP / XXL FLOOR-TABLE LAMP /  
LAMP WITH PEG / SUSPENSION LAMP / WALL LAMP / ACCESSORIES



Poldina lamp with peg white  
→ **LD0282B3**  
Porto Caleri  
Rovigo, Italy





Previous page:  
Poldina table lamp white → **LD0340B3**  
Poldina table lamp dark grey → **LD0340N3**

Current page: Poldina XXL floor-table  
lamp dark grey → **LD0360N3**  
Linder Cycling Hotel - Bolzano, Italy  
Photo Tiberio Sorvillo







Current page: Poldina table  
lamp corten → **LD0340R3**  
Natu Restaurant, Athens  
Greece

Arch. Photography Giorgos Sfakianakis

Next page: Poldina mini  
table lamp white → **LD0320B3**  
Gran Caffè Quadri, Piazza San Marco  
Venice, Italy

Photo Maurizio Torresan Photographer

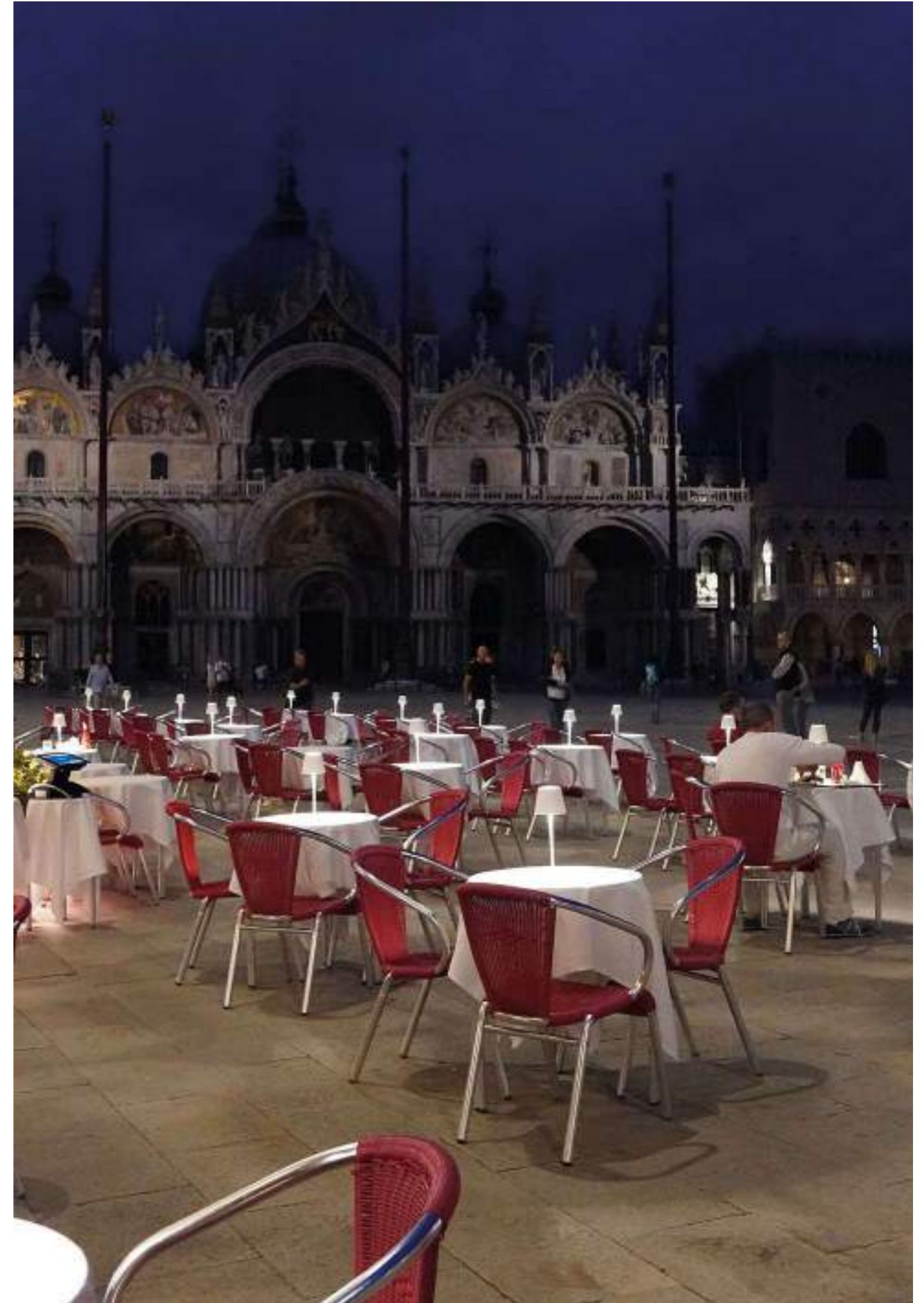



# Poldina

## Tavolo pro Table lamp pro

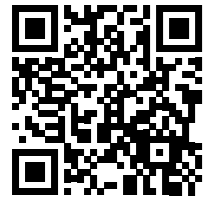

Video Poldina



Poldina è una lampada da tavolo a batteria, portatile e ricaricabile. Nella parte superiore della testa è presente un controllo "touch", che permette l'accensione, la regolazione dell'intensità luminosa e la selezione della temperatura di colore della luce tra 2200K, 2700K e 3000K. Grazie a un alto indice di protezione, la lampada è utilizzabile anche all'esterno (ad eccezione dei modelli con finitura a foglia metallica e finitura galvanica, delle quali è sconsigliato l'uso continuativo in esterni). Possiede un sistema di controllo elettronico che monitora e segnala l'autonomia residua della batteria, permettendo di ottimizzare le ricariche ed effettuarle sempre in maniera corretta. È dotata di base di ricarica a contatto; caricabatterie incluso. È possibile personalizzare la lampada con cover in ceramica, acquistabili separatamente (pag. 54).

Poldina is a rechargeable battery-powered cordless table lamp. A "touch" control on the head allows switching on/off, dimming, and selecting the color temperature of the light (2200K, 2700K or 3000K). It is suitable for both indoor and outdoor use (except gold, silver, and copper finishes). An electronic control system monitors the remaining autonomy and ensures a constant luminous flux until the battery runs out. Recharging is therefore optimized and always properly done. Poldina comes with a contact charging base; the battery charger is included. The lamp can be customized with a ceramic cover, to be purchased separately (pg. 54).

### Dati tecnici Technical data

LED TOUCH DIMMER | 100-240V | 2200-2700-3000K | CRI>80 | 50-60Hz | 2,2W | 234-251-256lm | **IP65** | 5Vdc max 1A

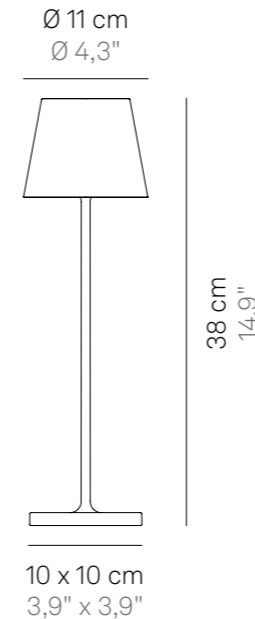

9,4 x 9,4 cm  
3,7" x 3,7"

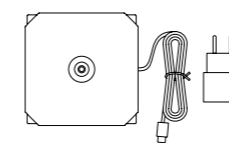

### Componenti inclusi Components included

Base di ricarica a contatto  
Contact charging base  
Caricabatterie  
Charger

Corpo in pressofusione di alluminio verniciato  
Painted die-cast aluminum body

Schermo diffusore in policarbonato  
Polycarbonate diffuser

Adatta all'uso esterno (lampada IP65) e interno (lampada su base di ricarica IP20) → legenda pag. 208  
Suitable for outdoor (lamp IP65) and indoor use (lamp on charging base IP20) → legend pg. 208

Durata di circa 12 h alla massima potenza  
Battery lasts about 12 h at full power

Tempo di ricarica a 1A: 6/7 h  
Charging time at 1A: 6/7 h

Pacco batteria al litio ricaricabile e sostituibile  
Rechargeable and replaceable lithium battery pack

### Avvertenze Remarks

Le lampade con finitura foglia color oro, foglia color argento e foglia color rame e con finitura galvanica lucida oro e cromo non sono adatte per uso esterno. The lamps with gold color leaf, silver color leaf and copper color leaf finish and with gold and chrome glossy galvanic finish are not suitable for outdoor use.

Per effetto della natura manuale della tecnica adottata nella lavorazione con foglia metallica, l'aspetto finale della finitura delle lampade può risultare differente. Eventuali difformità attestano il pregio e l'unicità di ciascuna lampada e non vanno considerate come imperfezioni. Due to the manual nature of the technique adopted in the application of the metal foil, the final appearance of the lamps' finishing can be different. Any apparent imperfections attest to the quality and exclusivity of each lamp and should not be considered as imperfections.



**Finiture**  
Finishes



**LD0340B3**  
Bianco / White  
RAL 9003

**LD0340R3**  
Corten

**LD0340N3**  
Grigio scuro / Dark grey

**LD0340S3**  
Sabbia / Sand



**LD0340X3**  
Bordeaux / Burgundy  
RAL 3005

**LD0340M3**  
Verde scuro / Dark green  
RAL 6005

**LD0340O3 \***  
Oro lucido  
/ Glossy gold

**LD0340C3 \***  
Cromo lucido  
/ Glossy chrome

\* Le lampade con finitura galvanica lucida oro e cromo non sono adatte per uso esterno e sono dotate della funzione di selezione della temperatura di colore della luce tra 2700 K e 3000 K.

\* The lamps with gold and chrome glossy galvanic finish are not suitable for outdoor use and they are equipped with a light color temperature selection function 2700 K or 3000 K.

**Finiture**  
Finishes



**LD0340G3**  
Salvia / Sage green  
Pantone 5635 U

**LD0340A3**  
Blu avio / Avio blue  
Pantone 7468 U

**LD0340P3**  
Rosa / Pink  
Pantone 698 U

**LD0340F3**  
Rosso / Red  
RAL 3000



**LD0340BFO \***  
Foglia color oro  
/ Gold color leaf

**LD0340BFA \***  
Foglia color argento  
/ Silver color leaf

**LD0340RFR \***  
Foglia color rame  
/ Copper color leaf

\* Le lampade con finitura foglia color oro, foglia color argento e foglia color rame non sono adatte per uso esterno.  
\* The lamps with gold color leaf, silver color leaf and copper color leaf finish are not suitable for outdoor use.

**poldina** x PEANUTS

**Tavolo pro**  
Table lamp pro



Poldina x Peanuts è l'edizione speciale di Poldina, lampada da tavolo a batteria portatile e ricaricabile, personalizzata con i personaggi creati da Charles Schulz. Peanuts, la striscia creata da Charles Schulz e pubblicata dal 1950, è uno dei fumetti più conosciuti al mondo. Poetici, teneri e ironici, i suoi personaggi sono figure classiche e senza tempo, in cui ogni lettore può riconoscersi.

Poldina x Peanuts is a special edition of the rechargeable battery-powered cordless table lamp Poldina, customized with characters created by Charles Schulz. Peanuts, first published in 1950, is one of the best-known comic strips in the world. Each member of the Peanuts gang is a classic, timeless figure with whom every reader can identify.

Poldina x Peanuts table lamp  
Aviator → **LD0340FP1**





**Dati tecnici**

## Technical data

LED TOUCH DIMMER | 100-240V | 2200-2700-3000K | CRI>80 | 50-60Hz | 2,2W | 234-251-256lm | **IP65** | 5Vdc max 1A



Corpo in pressofusione di alluminio verniciato

Painted die-cast aluminum body

Schermo diffusore in policarbonato

Polycarbonate diffuser

Adatta all'uso esterno (lampada IP65) e interno (lampada su base di ricarica IP20) → legenda pag. 208

Suitable for outdoor (lamp IP65) and indoor use (lamp on charging base IP20) → legend pg. 208

Durata di circa 12 h alla massima potenza

Battery lasts about 12 h at full power

Tempo di ricarica a 1A: 6/7 h

Charging time at 1A: 6/7 h

Pacco batteria al litio ricaricabile e sostituibile

Rechargeable and replaceable lithium battery pack

Ø 11 cm  
Ø 4,3"

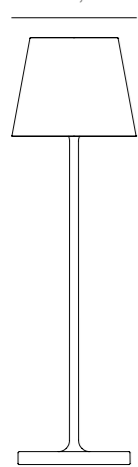

38 cm  
14,9"

10 x 10 cm  
3,9" x 3,9"

9,4 x 9,4 cm  
3,7" x 3,7"

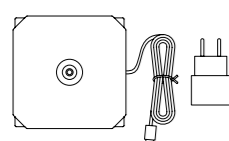
**Componenti inclusi**

Components included

Base di ricarica a contatto

Contact charging base

Caricabatterie

Charger

**Finiture**

## Finishes

**LD0340FP1**

Aviator

RAL 3000

**LD0340BP2**

Heart

RAL 9003

**LD0340BP3**

Friends

RAL 9003

**LD0340BP4**

Strip

RAL 9003

**LD0340RP5**

Together



# Poldina mini

## Tavolo pro Table lamp pro



Poldina mini è una lampada da tavolo a batteria, portatile e ricaricabile. Nella parte superiore della testa è presente un controllo "touch", che permette l'accensione, la regolazione dell'intensità luminosa e la selezione della temperatura di colore della luce tra 2200K, 2700K e 3000K. Grazie a un alto indice di protezione, la lampada è utilizzabile anche all'esterno (ad eccezione dei modelli con finitura a foglia metallica e finitura galvanica, delle quali è sconsigliato l'uso continuativo in esterni). Possiede un sistema di controllo elettronico che monitora e segnala l'autonomia residua della batteria, permettendo di ottimizzare le ricariche ed effettuarle sempre in maniera corretta. È dotata di base di ricarica a contatto; caricabatterie incluso. È possibile personalizzare la lampada con cover in ceramica, acquistabili separatamente

Poldina mini is a rechargeable battery-powered cordless table lamp. A "touch" control on the head allows switching on/off, dimming, and selecting the color temperature of the light (2200K, 2700K or 3000K). It is suitable for both indoor and outdoor use (except gold, silver, and copper finishes). An electronic control system monitors the remaining autonomy and ensures a constant luminous flux until the battery runs out. Recharging is therefore optimized and always properly done. Poldina comes with a contact charging base; the battery charger is included. The lamp can be customized with a ceramic cover, to be purchased separately

### Dati tecnici Technical data

LED TOUCH DIMMER | 100-240V | 2200-2700-3000K | CRI>80 | 50-60Hz | 2,2W | 234-251-256lm | **IP65** | 5Vdc max 1A

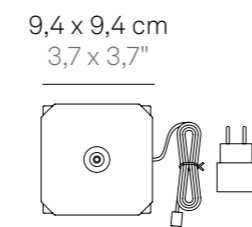
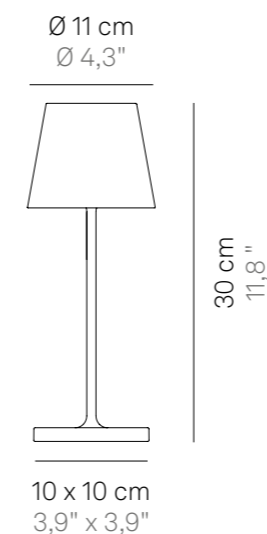

Corpo in pressofusione di alluminio verniciato  
Painted die-cast aluminum body

Schermo diffusore in policarbonato  
Polycarbonate diffuser

Adatta all'uso esterno (lampada IP65) e interno (lampada su base di ricarica IP20) → legenda pag. 208  
Suitable for outdoor (lamp IP65) and indoor use (lamp on charging base IP20) → legend pg. 208

Durata di circa 12 h alla massima potenza  
Battery lasts about 12 h at full power

Tempo di ricarica a 1A: 6/7 h  
Charging time at 1A: 6/7 h

Pacco batteria al litio ricaricabile e sostituibile  
Rechargeable and replaceable lithium battery pack

### Avvertenze Remarks

Le lampade con finitura foglia color oro, foglia color argento e foglia color rame e con finitura galvanica lucida oro e cromo non sono adatte per uso esterno.  
The lamps with gold color leaf, silver color leaf and copper color leaf finish and with gold and chrome glossy galvanic finish are not suitable for outdoor use.

Per effetto della natura manuale della tecnica adottata nella lavorazione con foglia metallica, l'aspetto finale della finitura delle lampade può risultare differente. Eventuali difformità attestano il pregio e l'unicità di ciascuna lampada e non vanno considerate come imperfezioni.

Due to the manual nature of the technique adopted in the application of the metal foil, the final appearance of the lamps' finishing can be different. Any apparent imperfections attest to the quality and exclusivity of each lamp and should not be considered as imperfections.

### Componenti inclusi Components included

Base di ricarica a contatto  
Contact charging base  
Caricabatterie  
Charger



Finiture  
Finishes



**LD0320B3**

Bianco / White  
RAL 9003

**LD0320R3**

Corten

**LD0320N3**

Grigio scuro / Dark grey

**LD0320S3**

Sabbia / Sand

Finiture  
Finishes



**LD0320BFO \***

Foglia color oro  
/ Gold color leaf

**LD0320BFA \***

Foglia color argento  
/ Silver color leaf

**LD0320RFR \***

Foglia color rame  
/ Copper color leaf



Poldina mini table  
lamp dark grey  
→ **LD0320N3**



**LD0320O3 \***

Oro lucido  
/ Glossy gold

**LD0320C3 \***

Cromo lucido  
/ Glossy chrome

\* Le lampade con finitura foglia color oro, foglia color argento e foglia color rame e con finitura galvanica lucida oro e cromo non sono adatte per uso esterno. Le finiture cromate sono dotate della funzione di selezione della temperatura di colore della luce tra 2700 K e 3000 K.

\* The lamps with gold color leaf, silver color leaf, copper color leaf finish and with gold and chrome glossy galvanic finish are not suitable for outdoor use. The lamps with glossy finish are equipped with a light color temperature selection function 2700 K or 3000 K.

# Poldina micro

## Tavolo pro Table lamp pro



Premio Barawards 2022  
Innovazione dell'Anno

Barawards 2022 Innovation  
of the Year Award



Poldina micro è una lampada da tavolo a batteria, portatile e ricaricabile. Nella parte superiore della testa è presente un controllo "touch", che permette l'accensione, la regolazione dell'intensità luminosa e la selezione della temperatura di colore della luce tra 2200K, 2700K e 3000K. Grazie a un alto indice di protezione, la lampada è utilizzabile anche all'esterno (ad eccezione dei modelli con finitura galvanica, delle quali è sconsigliato l'uso continuativo in esterni). Possiede un sistema di controllo elettronico che monitora e segnala l'autonomia residua della batteria, permettendo di ottimizzare le ricariche ed effettuarle sempre in maniera corretta. È dotata di base di ricarica a contatto; caricabatterie non incluso.

Poldina micro is a rechargeable battery-powered cordless table lamp. A "touch" control on the head allows switching on/off, dimming, and selecting the color temperature of the light (2200K, 2700K or 3000K). It is suitable for both indoor and outdoor use (except gold and silver finishes). An electronic control system monitors the remaining autonomy and ensures a constant luminous flux until the battery runs out. Recharging is therefore optimized and always properly done. The lamp comes with a contact charging base; the battery charger is not included.

### Dati tecnici Technical data

LED TOUCH DIMMER | 2200-2700-3000K | CRI>80 | 1,8W | 174-177-195lm |  
**IP65** | 5 Vdc max 1A



Corpo in pressofusione di alluminio verniciato  
Painted die-cast aluminum body

Schermo diffusore in policarbonato  
Polycarbonate diffuser

Adatta all'uso esterno (lampada IP65) e interno (lampada su base di ricarica IP20) → legenda pag. 208  
Suitable for outdoor (lamp IP65) and indoor use (lamp on charging base IP20) → legend pg. 208

Durata di circa 7/8 h alla massima potenza  
Battery lasts about 7/8 h at full power

Tempo di ricarica a 1A: 3 h  
Charging time at 1A: 3 h

Pacco batteria al litio ricaricabile e sostituibile  
Rechargeable and replaceable lithium battery pack

### Avvertenze Remarks

Le lampade con finitura galvanica lucida oro e cromo non sono adatte per uso esterno.  
The lamps with gold and chrome glossy galvanic finish are not suitable for outdoor use.

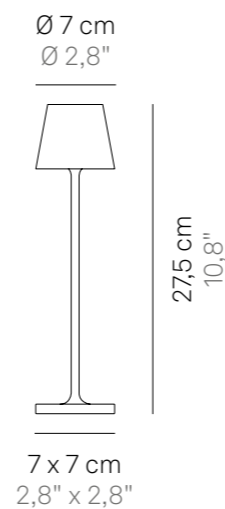

6,7 x 6,7 cm  
2,6" x 2,6"

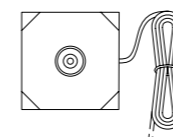

### Componenti inclusi Components included

Base di ricarica a contatto  
Contact charging base

### Accessori non inclusi Accessories not included

Caricabatterie → pag. 199  
Charger → pg. 199





Current page:  
Poldina micro table lamp white → **LD0490B3**

Next page: Poldina micro  
table lamp glossy gold → **LD049003**  
Poldina table lamp white → **LD0340B3**



**Finiture**  
Finishes



**LD0490B3**  
Bianco / White  
RAL 9003



**LD0490R3**  
Corten



**LD0490N3**  
Grigio scuro / Dark grey



**LD0490D3**  
Nero / Black  
RAL 9004



**LD0490S3**  
Sabbia / Sand



**LD0490G3**  
Salvia / Sage green  
Pantone 5635 U



**LD0490P3**  
Rosa / Pink  
Pantone 698 U



**LD0490F3**  
Rosso / Red  
RAL 3000

**Finiture**  
Finishes



**LD0490K3**  
Blu Capri / Capri blue  
RAL 5019



**LD0490L3**  
Lilla / Lilac  
RAL 4005



**LD0490V3**  
Verde mela / Apple green  
RAL 6018



**LD0490Z3**  
Arancio / Orange  
RAL 2008



**LD0490O3 \***  
Oro lucido / Glossy gold



**LD0490C3 \***  
Cromo lucido / Glossy chrome

\* Le lampade con finitura galvanica lucida oro e cromo non sono adatte per uso esterno.  
\* The lamps with gold and chrome glossy galvanic finish are not suitable for outdoor use.

# Poldina L desk

## Tavolo pro Table lamp pro

NEW



Poldina L desk è una lampada da tavolo a batteria, portatile e ricaricabile. Nella parte superiore della testa è presente un controllo "touch", che permette l'accensione, la regolazione dell'intensità luminosa e la selezione della temperatura di colore della luce tra 2200K, 2700K e 3000K. Grazie a un alto indice di protezione, la lampada è utilizzabile anche all'esterno. Possiede un sistema di controllo elettronico che monitora e segnala l'autonomia residua della batteria, permettendo di ottimizzare le ricariche ed effettuarle sempre in maniera corretta. È dotata di base di ricarica a contatto; caricabatterie incluso.

Poldina L desk is a rechargeable battery-powered cordless table lamp. A "touch" control on the head allows switching on/off, dimming, and selecting the color temperature of the light (2200K, 2700K or 3000K). It is suitable for both indoor and outdoor use. An electronic control system monitors the remaining autonomy and ensures a constant luminous flux until the battery runs out. Recharging is therefore optimized and always properly done. The lamp comes with a contact charging base; the battery charger is included.

Poldina L desk table  
lamp dark grey → LD0395N3





**Dati tecnici**

## Technical data

LED TOUCH DIMMER | 100-240V | 2200-2700-3000K | CRI>80 | 50-60Hz | 5,5W | 479- 540-550lm | **IP54** | 5Vdc max 1A



Corpo in pressofusione di alluminio verniciato

Painted die-cast aluminum body

Schermo diffusore in policarbonato

Polycarbonate diffuser

Adatta all'uso esterno (lampada IP54) e interno (lampada su base di ricarica IP20) → legenda pag. 208

Suitable for outdoor (lamp IP54) and indoor use (lamp on charging base IP20) → legend pg. 208

Durata di circa 11 h alla massima potenza

Battery lasts about 11 h at full power

Tempo di ricarica a 1A: 11 h

Charging time at 1A: 11 h

Pacco batteria al litio ricaricabile e sostituibile

Rechargeable and replaceable lithium battery pack

Ø 16,5 cm  
Ø 6,5"

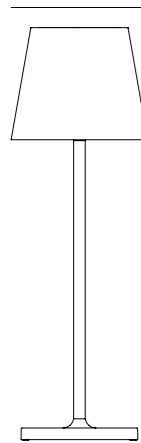

49,7 cm  
19,6"

14 x 14 cm  
5,5" x 5,5"

13,5 x 13,5 cm  
5,3" x 5,3"

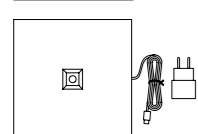
**Componenti inclusi**

## Components included

Base di ricarica a contatto

Contact charging base

Caricabatterie

Charger

**Finiture**

## Finishes

**LD0395B3**

Bianco / White

RAL 9003

**LD0395R3**

Corten

**LD0395N3**

Grigio scuro / Dark grey



# Poldina L

## Tavolo-terra pro Floor-table lamp pro

Poldina L è una lampada da terra e da tavolo a batteria, portatile e ricaricabile. Nella parte superiore della testa è presente un controllo "touch", che permette l'accensione, la regolazione dell'intensità luminosa e la selezione della temperatura di colore della luce tra 2200K, 2700K e 3000K. Grazie a un alto indice di protezione, la lampada è utilizzabile anche all'esterno. Possiede un sistema di controllo elettronico che monitora e segnala l'autonomia residua della batteria, permettendo di ottimizzare le ricariche ed effettuarle sempre in maniera corretta. È dotata di base di ricarica a contatto; caricabatterie incluso. È fornita con un kit di 3 aste che permette di configurarne l'altezza in tre misure: 52, 87 o 122 cm.



Poldina L is a rechargeable battery-powered cordless floor and table lamp. A "touch" control on the head allows switching on/off, dimming, and selecting the color temperature of the light (2200K, 2700K or 3000K). It is suitable for both indoor and outdoor use. An electronic control system monitors the remaining autonomy and ensures a constant luminous flux until the battery runs out. Recharging is therefore optimized and always properly done. The lamp comes with a contact charging base; the battery charger is included. It is provided with a 3-rod kit that allows to choose the height of the lamp among 52, 87 or 122 cm.

Poldina L floor-table lamp  
white → **LD0390B3**



**Dati tecnici**

## Technical data

LED TOUCH DIMMER | 100-240V | 2200-2700-3000K | CRI>80 | 50-60Hz | 5,5W | 479- 540-550lm | **IP54** | 5Vdc max 1A



Corpo in pressofusione di alluminio verniciato

Painted die-cast aluminum body

Schermo diffusore in policarbonato

Polycarbonate diffuser

Adatta all'uso esterno (lampada IP54) e interno (lampada su base di ricarica IP20) → legenda pag. 208

Suitable for outdoor (lamp IP54) and indoor use (lamp on charging base IP20) → legend pg. 208

Durata di circa 11 h alla massima potenza

Battery lasts about 11 h at full power

Tempo di ricarica a 1A: 11 h

Charging time at 1A: 11 h

Pacco batteria al litio ricaricabile e sostituibile

Rechargeable and replaceable lithium battery pack

Ø 16,5 cm  
Ø 6,5"

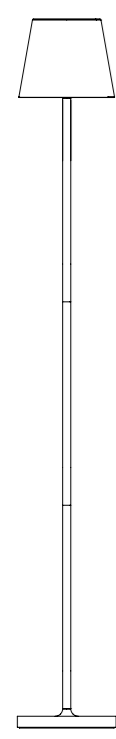

122 cm  
48"

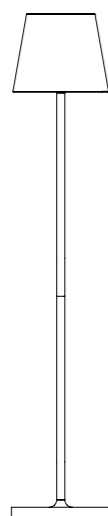

87 cm  
34,2"

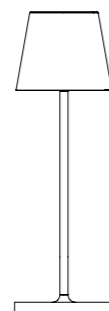

52 cm  
20,4"

17 x 17 cm  
6,6" x 6,6"

15 x 15 cm  
5,9" x 5,9"

35 cm  
13,8"

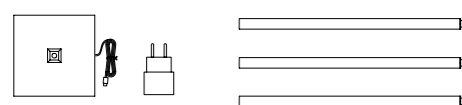
**Componenti inclusi**

Components included

Base di ricarica a contatto

Contact charging base

Caricabatterie

Charger

Stelo (3 pz.)

Stem (3 pcs.)

**Finiture**

## Finishes



**LD0390B3**

Bianco / White

RAL 9003



**LD0390R3**

Corten



**LD0390N3**

Grigio scuro / Dark grey



# Poldina XXL

## Tavolo-terra pro Floor-table lamp pro



Poldina XXL è una lampada da terra e da tavolo a batteria, portatile e ricaricabile. Nella parte superiore dello stelo è presente un controllo "touch", che permette l'accensione, la regolazione dell'intensità luminosa e la selezione della temperatura di colore della luce tra 2700K e 3000K. Grazie a un alto indice di protezione, la lampada è utilizzabile anche all'esterno. È dotata di base di ricarica a contatto; caricabatterie incluso. È fornita con un kit di 3 aste che permette di configurarne l'altezza in tre misure: 69, 110 o 150 cm.

Poldina XXL is a rechargeable battery-powered cordless floor and table lamp. A "touch" control on the upper part of the stem allows switching on/off, dimming, and selecting the color temperature of the light (2700K or 3000K). It is suitable for both indoor and outdoor use. The lamp comes with a contact charging base; the battery charger is included. It is provided with a 3-rod kit that allows to choose the height of the lamp among 69, 110 or 150 cm.



Poldina XXL floor-table lamp  
dark grey → **LD0360N3**

**Dati tecnici**

Technical data

LED TOUCH DIMMER | 100-240V |  
2700-3000K | CRI>80 | 50-60Hz | 6,5W |  
470-500lm | **IP54** | 5Vdc max 1A



Ø 28 cm  
Ø 11"

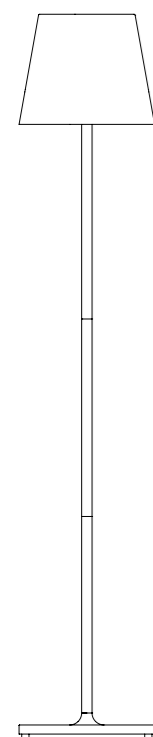

150 cm  
59"

28 x 28 cm  
11" x 11"

Ø 24,7 cm  
Ø 9,7"

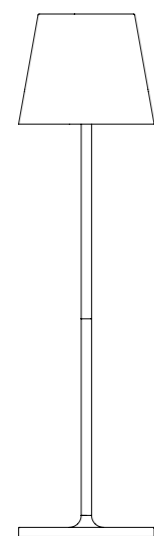
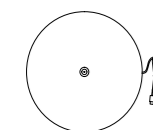

110 cm  
43,3"

40 cm  
15,7"

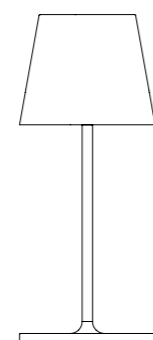
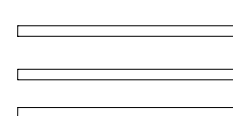

69,5 cm  
27,3"

Ø 24,7 cm  
Ø 9,7"



Corpo in pressofusione di alluminio verniciato  
Painted die-cast aluminum body

Schermo diffusore in policarbonato  
Polycarbonate diffuser

Adatta all'uso esterno (lampada IP54) e interno  
(lampada su base di ricarica IP20) → legenda pag. 208  
Suitable for outdoor (lamp IP54) and indoor use  
(lamp on charging base IP20) → legend pg. 208

Durata di circa 15 h alla massima potenza  
Battery lasts about 15 h at full power

Tempo di ricarica a 1A: 20 h  
Charging time at 1A: 20 h

Pacco batteria al litio ricaricabile e sostituibile  
Rechargeable and replaceable lithium battery pack

**Componenti inclusi**

Components included

Base di ricarica a contatto  
Contact charging base

Caricabatterie  
Charger

Stelo (3 pz.)  
Stem (3 pcs.)

**Finiture**

Finishes



**LD0360B3**  
Bianco / White  
RAL 9003

**LD0360R3**  
Corten

**LD0360N3**  
Grigio scuro / Dark grey



# Poldina

## Picchetto pro

Lamp with peg pro



Poldina è una lampada a batteria, portatile e ricaricabile con picchetto. Nella parte superiore della testa è presente un controllo "touch", che permette l'accensione, la regolazione dell'intensità luminosa e la selezione della temperatura di colore della luce tra 2200K, 2700K e 3000K. Grazie a un alto indice di protezione, la lampada è utilizzabile anche all'esterno. Possiede un sistema di controllo elettronico che monitora e segnala l'autonomia residua della batteria, permettendo di ottimizzare le ricariche ed effettuarle sempre in maniera corretta. È dotata di testa magnetica che si rimuove in modo pratico e si ricarica comodamente sulla propria base di ricarica a contatto; caricabatterie incluso. È possibile personalizzare la lampada con cover in ceramica, acquistabili separatamente. Come accessori, sono disponibili aste aggiuntive che permettono di aumentare l'altezza della lampada.

Poldina is a rechargeable battery-powered cordless lamp with peg. A "touch" control on the head allows switching on/off, dimming, and selecting the color temperature of the light (2200K, 2700K or 3000K). It is suitable for both indoor and outdoor use. An electronic control system monitors the remaining autonomy and ensures a constant luminous flux until the battery runs out. Recharging is therefore optimized and always properly done. The lamp comes with magnetic head, which can be removed easily and recharged conveniently on their own contact charging base; the battery charger is included. It can be customized with a ceramic cover, to be purchased separately. Additional stem extensions are available as accessories to increase the height of the lamp (to be purchased separately).



Poldina lamp with peg white → **LD0682B3**



**Dati tecnici**

## Technical data

LED TOUCH DIMMER | 100-240V | 2200-2700-3000K | CRI>80 | 50-60Hz | 2,2W | 234-251-256lm | **IP54** | 5Vdc max 1A



Corpo in pressofusione di alluminio verniciato

Painted die-cast aluminum body

Schermo diffusore in policarbonato

Polycarbonate diffuser

Adatta all'uso esterno (lampada IP54) e interno (lampada su base di ricarica IP20) → legenda pag. 208

Suitable for outdoor (lamp IP54) and indoor use (lamp on charging base IP20) → legend pg. 208

Durata di circa 9 h alla massima potenza

Battery lasts about 9 h at full power

Tempo di ricarica a 1A: 6 h

Charging time at 1A: 6 h

Pacco batteria al litio ricaricabile e sostituibile

Rechargeable and replaceable lithium battery pack

**Avvertenze**

## Remarks

La stabilità della lampada è garantita con l'uso di massimo tre prolunghe

The stability of the lamp is guaranteed when using three extensions maximum

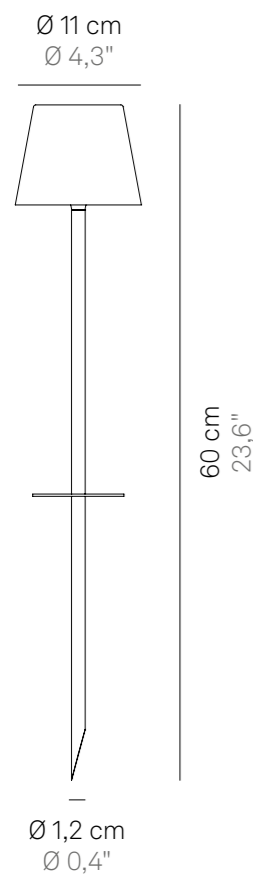

Ø 10,2 cm  
Ø 4"

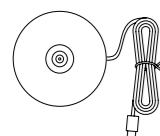
**Componenti inclusi**

## Components included

Base di ricarica a contatto

Contact charging base

**Accessori non inclusi**

## Accessories not included

Caricabatterie → pag. 199

Charger → pg. 199

Prolunga stelo aggiuntiva → pag. 45

Additional stem extension → pg. 45

**Finiture**

## Finishes

**LD0682B3**

Bianco / White

RAL 9003

**LD0682R3**

Corten

**LD0682N3**

Grigio scuro / Dark grey

**Prolunga stelo aggiuntiva (non inclusa)**

## Additional stem extension (not included)

25 cm  
9,8"

25 cm  
9,8"

25 cm  
9,8"

**LD0283B3**

Bianco / White

RAL 9003

**LD0283R3**

Corten

**LD0283N3**

Grigio scuro / Dark grey

# Poldina

## Sospensione pro Suspension lamp pro



Poldina è una lampada a batteria, portatile e ricaricabile a sospensione. Nella parte superiore della testa è presente un controllo "touch", che permette l'accensione, la regolazione dell'intensità luminosa e la selezione della temperatura di colore della luce tra 2200K, 2700K e 3000K. Grazie a un alto indice di protezione, la lampada è utilizzabile anche all'esterno. Possiede un sistema di controllo elettronico che monitora e segnala l'autonomia residua della batteria, permettendo di ottimizzare le ricariche ed effettuarle sempre in maniera corretta. È dotata di testa magnetica che si rimuove in modo pratico e si ricarica comodamente sulla propria base di ricarica a contatto; caricabatterie incluso. È possibile personalizzare la lampada con cover in ceramica, acquistabili separatamente.

Poldina is a rechargeable battery-powered cordless suspension lamp. A "touch" control on the head allows switching on/off, dimming, and selecting the color temperature of the light (2200K, 2700K or 3000K). It is suitable for both indoor and outdoor use. An electronic control system monitors the remaining autonomy and ensures a constant luminous flux until the battery runs out. Recharging is therefore optimized and always properly done. The lamp comes with magnetic head, which can be removed easily and recharged conveniently on their own contact charging base; the battery charger is included. It can be customized with a ceramic cover, to be purchased separately.

Poldina suspension lamp  
white → **LD0686B3**





**Dati tecnici**

## Technical data

LED TOUCH DIMMER | 100-240V | 2200-2700-3000K | CRI>80 | 50-60Hz | 2,2W | 234-251-256lm | **IP54** | 5Vdc max 1A



Corpo in pressofusione di alluminio verniciato

Painted die-cast aluminum body

Schermo diffusore in policarbonato

Polycarbonate diffuser

Adatta all'uso esterno (lampada IP54) e interno (lampada su base di ricarica IP20) → legenda pag. 208

Suitable for outdoor (lamp IP54) and indoor use (lamp on charging base IP20) → legend pg. 208

Durata di circa 9 h alla massima potenza

Battery lasts about 9 h at full power

Tempo di ricarica a 1A: 6 h

Charging time at 1A: 6 h

Pacco batteria al litio ricaricabile e sostituibile

Rechargeable and replaceable lithium battery pack

Ø 11 cm  
Ø 4,3"

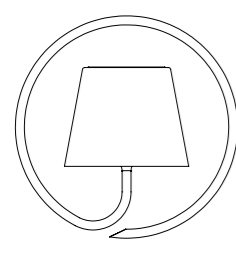

19,8 cm  
7,8"

19,8 cm  
7,8"

Ø 10,2 cm  
Ø 4"

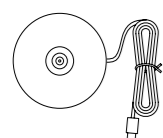
**Componenti inclusi**

Components included

Base di ricarica a contatto  
Contact charging base

**Accessori non inclusi**

Accessories not included

Caricabatterie → pag. 199  
Charger → pg. 199

**Finiture**

## Finishes

**LD0686B3**

Bianco / White  
RAL 9003

**LD0686R3**

Corten

**LD0686N3**

Grigio scuro / Dark grey



Poldina suspension lamp  
corten → **LD0686R3**



# Poldina

## Parete pro

Wall lamp pro



Poldina è una lampada a batteria, portatile e ricaricabile da parete, disponibile in due versioni. Nella parte superiore della testa è presente un controllo "touch", che permette l'accensione, la regolazione dell'intensità luminosa e la selezione della temperatura di colore della luce tra 2200K, 2700K e 3000K. Grazie a un alto indice di protezione, la lampada è utilizzabile anche all'esterno. Possiede un sistema di controllo elettronico che monitora e segnala l'autonomia residua della batteria, permettendo di ottimizzare le ricariche ed effettuarle sempre in maniera corretta. È dotata di testa magnetica che si rimuove in modo pratico e si ricarica comodamente sulla propria base di ricarica a contatto; caricabatterie incluso. È possibile personalizzare la lampada con cover in ceramica, acquistabili separatamente.

Poldina is a rechargeable battery-powered cordless wall lamp. A "touch" control on the head allows switching on/off, dimming, and selecting the color temperature of the light (2200K, 2700K or 3000K). It is suitable for both indoor and outdoor use. An electronic control system monitors the remaining autonomy and ensures a constant luminous flux until the battery runs out. Recharging is therefore optimized and always properly done. The lamp comes with magnetic head, which can be removed easily and recharged conveniently on their own contact charging base; the battery charger is included. It can be customized with a ceramic cover, to be purchased separately.



Poldina wall lamp dark grey  
→ LD0688N3

**Dati tecnici**

## Technical data

LED TOUCH DIMMER | 100-240V | 2200-2700-3000K | CRI>80 | 50-60Hz | 2,2W | 234-251-256lm | **IP54** | 5Vdc max 1A

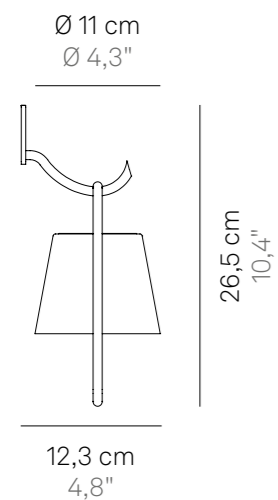
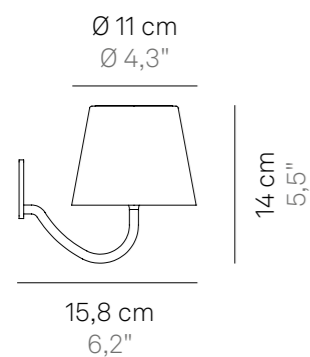

Ø 10,2 cm  
Ø 4"

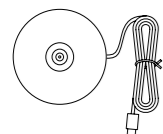

**Componenti inclusi**  
Components included

Base di ricarica a contatto  
Contact charging base

Corpo in pressofusione di alluminio verniciato  
Painted die-cast aluminum body

Schermo diffusore in policarbonato  
Polycarbonate diffuser

Adatta all'uso esterno (lampada IP54) e interno (lampada su base di ricarica IP20) → legenda pag. 208  
Suitable for outdoor (lamp IP54) and indoor use (lamp on charging base IP20) → legend pg. 208

Durata di circa 9 h alla massima potenza  
Battery lasts about 9 h at full power

Tempo di ricarica a 1A: 6 h  
Charging time at 1A: 6 h

Pacco batteria al litio ricaricabile e sostituibile  
Rechargeable and replaceable lithium battery pack

**Accessori non inclusi**  
Accessories not included

Caricabatterie → pag. 199  
Charger → pg. 199

**Finiture**

## Finishes



**LD0688B3**  
Bianco / White  
RAL 9003



**LD0688R3**  
Corten



**LD0688N3**  
Grigio scuro / Dark grey



**LD0689B3**  
Bianco / White  
RAL 9003



**LD0689R3**  
Corten



**LD0689N3**  
Grigio scuro / Dark grey

# Poldina

## Cover in ceramica made in Italy

Ceramic cover made in Italy

NEW

Accessorio per / Accessory for:  
 Poldina table lamp (pg. 12)  
 Poldina mini table lamp (pg. 20)  
 Poldina lamp with peg (pg. 42)  
 Poldina suspension lamp (pg. 46)  
 Poldina wall lamp (pg. 50)  
 Poldina Reverso table lamp (pg. 60)



### Dati tecnici

Technical data

CE

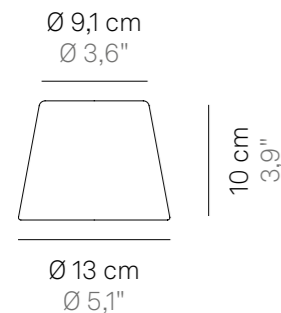

**Componenti inclusi**  
 Components included

Magnete  
 Magnet

**Video tutorial:** montaggio cover  
 Tutorial video: installation of the cover



Cover in ceramica che si fissa alla testa della lampada Poldina tramite adesivi. La stretta collaborazione con un'antica fabbrica di Civita Castellana - borgo viterbese dove l'arte della ceramica è attestata fin dal X secolo a.C. - consente a Zafferano di avvalersi di una produzione esclusiva di manufatti "Made in Italy", decorati a mano su disegno proprio o del cliente.

Ceramic cover that is fixed to the head of the lamp with adhesive strips. The close partnership with a historic factory in Civita Castellana - a village near Rome, where the art of ceramics has been practiced since the 10th century BC - allows Zafferano to rely on the exclusive production of made in Italy artifacts, which are hand-painted according to Zafferano design; customization available.

**Finiture**  
 Finishes



**LD035000**  
 Righe verdi  
 Green stripes



**LD035001**  
 Righe gialle  
 Yellow stripes



**LD035002**  
 Righe blu  
 Blue stripes



**LD035003**  
 Righe rosse  
 Red stripes



**LD035004**  
 Pesci azzurri  
 Light blue fish



Poldina table lamp Avio blue → LD0340A3  
 Ceramic cover → LD035004





Poldina wall lamp white + ceramic cover  
→ **LD0340B3 + LD035000**



# Poldina Reverso

Design Federico de Majo

Come sono belli e delicati  
i piccoli fiori del tuo davanzale.  
Se illuminati i loro colori  
si trasformano in cristalli: dolci e salati,  
diventano un piccolo tesoro  
o le chiavi della felicità.

What beautiful, tiny and  
delicate flowers on your windowsill.  
When illuminated their colours  
turn into crystals: sweet and savoury,  
they become a little treasure  
or the keys to happiness.

TAVOLO  
TABLE LAMP



Poldina Reverso table  
lamp white → **LD0420B3**  
Porto Caleri  
Rovigo, Italy



# Poldina Reverso

## Tavolo pro Table lamp pro

NEW



Video Poldina Reverso



Poldina Reverso è una lampada da tavolo a batteria, portatile e ricaricabile, con contenitore multiuso. Nella parte inferiore della testa è presente un controllo "touch", che permette l'accensione, la regolazione dell'intensità luminosa e la selezione della temperatura di colore della luce tra 2200K, 2700K e 3000K. Grazie a un alto indice di protezione, la lampada è utilizzabile anche all'esterno. Il contenitore multiuso (capacità 18 cl) in resina termoplastica adatta al contatto alimentare (PET) è removibile e riutilizzabile. Possiede un sistema di controllo elettronico che monitora e segnala l'autonomia residua della batteria, permettendo di ottimizzare le ricariche ed effettuarle sempre in maniera corretta. È dotata di base di ricarica a contatto; caricabatterie incluso. È possibile personalizzare la lampada con cover in ceramica, acquistabili separatamente

Poldina Reverso is a rechargeable battery-powered cordless table lamp, with a multipurpose storage tray. A "touch" control smartly placed on the lower part of the head allows switching on/off, dimming, and selecting the color temperature of the light (2200K, 2700K or 3000K). It is suitable for both indoor and outdoor use. The multipurpose container tray (capacity 18cl) in thermoplastic resin suitable for food contact (PET) is removable and reusable. An electronic control system monitors the remaining autonomy and ensures a constant luminous flux until the battery runs out. Recharging is therefore optimized and always properly done. The lamp comes with a contact charging base; battery charger included. Poldina Reverso can be customized with a ceramic cover, to be purchased separately

Poldina Reverso table lamp  
white → LD0420B3











Poldina Reverso table lamp  
sage green → **LD0420G3**



Poldina Reverso table lamp  
dark grey → **LD0420N3**



Pulsante touch per l'accensione e dimmerazione  
Touch switch for on/off and dimming

Vaschetta contenitore multiuso  
(adatto anche per uso alimentare)  
Multipurpose container tray (suitable also for food)  
→ **LD0420V1**



Poldina Reverso table  
lamp corten → **LD0420R3**





**Dati tecnici**

## Technical data

LED TOUCH DIMMER | 100-240V | 2200-2700-3000K | CRI>80 | 50-60Hz | 2,3W | 241-250-262lm | **IP54** | 5Vdc max 1A

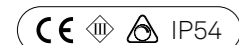

Corpo in pressofusione di alluminio verniciato

Painted die-cast aluminum body

Schermo diffusore in policarbonato satinato

Diffuser in satin-finish polycarbonate

Adatta all'uso esterno (lampada IP54) e interno (lampada su base di ricarica IP20) → legenda pag. 208

Suitable for outdoor (lamp IP54) and indoor use (lamp on charging base IP20) → legend pg. 208

Durata di circa 12 h alla massima potenza

Battery lasts about 12 h at full power

Tempo di ricarica a 1A: 6/7 h

Charging time at 1A: 6/7 h

Pacco batteria al litio ricaricabile e sostituibile

Rechargeable and replaceable lithium battery pack

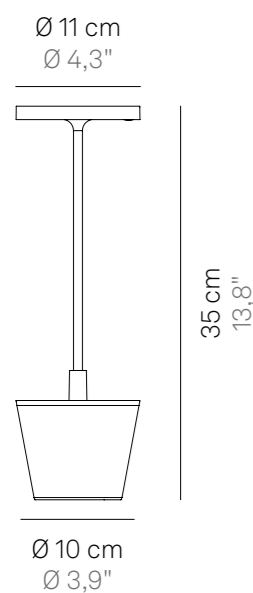

Ø 7,5 cm  
Ø 2,9"

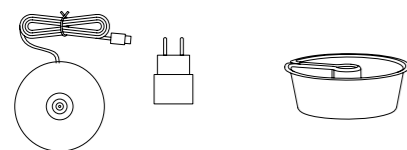
**Componenti inclusi**

Components included

Base di ricarica a contatto

Contact charging base

Caricabatterie

Charger

Vaschetta contenitore multiuso

Multipurpose container tray

**Finiture**

## Finishes

**LD0420B3**

Bianco / White  
RAL 9003

**LD0420R3**

Corten

**LD0420N3**

Grigio scuro / Dark grey

**LD0420S3**

Sabbia / Sand

**LD0420G3**

Salvia / Sage green  
Pantone 5635 U

# Ofelia

Edera, forte, intensa  
Giunte dopo un lungo errare  
Uniamo le nostre radici  
In un intimo cercarsi.

Ivy, strong and intense  
arriving after a long ramble  
we merge our roots  
in an intimate search.

TAVOLO  
TABLE LAMP



Ofelia table lamp white  
→ **LD1870B3**  
Storga river springs  
Treviso, Italy





Ofelia table lamp sage  
green → **LD1870G3**  
Ristorante Piastrino \*  
Pennabilli, Italy  
Photo Marco Poderi Studio

Ofelia table lamp  
sand → **LD1870S3**  
Ristorante Oltre  
Leporano, Italy  
Photo Giuseppe Musolino





# Ofelia

## Tavolo pro

Table lamp pro



Ofelia è una lampada da tavolo a batteria, portatile e ricaricabile. Nella parte superiore della testa è presente un controllo "touch", che permette l'accensione, la regolazione dell'intensità luminosa e la selezione della temperatura di colore della luce tra 2200K, 2700K e 3000K. Ofelia possiede inoltre la funzione di memoria dell'impostazione di dimmerazione, che memorizza gli step di dimmerazione: di conseguenza, ad ogni accensione, l'intensità luminosa corrisponderà a quella precedentemente impostata. Grazie a un alto indice di protezione, la lampada è utilizzabile anche all'esterno. È dotata di base di ricarica a contatto; caricabatterie incluso.

Ofelia is a rechargeable battery-powered cordless table lamp. A "touch" control on the head allows switching on/off, dimming, and selecting the color temperature of the light (2200K, 2700K or 3000K). Ofelia is equipped with the dimmer memory function, which adjusts the light intensity and memorizes the dimmer steps; consequently, every time it is switched on, the light intensity will correspond to that previously set. It is suitable for both indoor and outdoor use. The lamp comes with a contact charging base; battery charger included.

Ofelia table lamp sage green  
→ LD1870G3



**Dati tecnici**

## Technical data

LED TOUCH DIMMER | 100-240V |  
2200-2700-3000K | CRI>80 | 50-60Hz |  
2,2W | 231-244-252lm | **IP65** | 5Vdc max 1A



Corpo in pressofusione di alluminio verniciato  
Painted die-cast aluminum body

Schermo diffusore in policarbonato prismatico  
Prismatic polycarbonate diffuser

Adatta all'uso esterno (lampada IP65) e interno  
(lampada su base di ricarica IP20) → legenda pag. 208  
Suitable for outdoor (lamp IP65) and indoor use  
(lamp on charging base IP20) → legend pg. 208

Durata di circa 9 h alla massima potenza  
Battery lasts about 9 h at full power

Tempo di ricarica a 1A: 6 h  
Charging time at 1A: 6 h

Pacco batteria al litio ricaricabile e sostituibile  
Rechargeable and replaceable lithium battery pack

10 x 10 cm  
3,9 x 3,9"

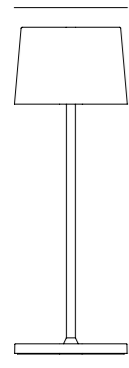

29 cm  
11,4"

10 x 10 cm  
3,9" x 3,9"

11,6 x 11,6 cm  
4,5" x 4,5"

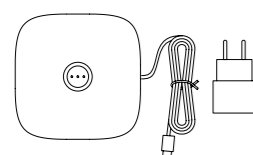
**Componenti inclusi**

## Components included

Base di ricarica a contatto  
Contact charging base

Caricabatterie  
Charger

**Finiture**

## Finishes



**LD1870B3**  
Bianco / White  
RAL 9016



**LD1870R3**  
Corten



**LD1870N3**  
Grigio scuro / Dark grey  
RAL 7024



**LD1870S3**  
Sabbia / Sand  
RAL 1014



**LD1870G3**  
Salvia / Sage green  
Pantone 5635U

# Olivia

We are the custodians  
of a pure stone manor  
with its strong presence  
and hard, rugged rock.  
Illuminated, it is softened  
and when night falls  
we keep vigil motionless.

Siamo custodi  
di un maniero di pura pietra  
forte presenza  
roccia dura ed aspra.  
Illuminata si addolcisce  
scesa la notte  
vegliamo immobili.

TAVOLO / MINI TAVOLO  
TABLE LAMP / MINI TABLE LAMP



Olivia table lamp white  
→ **LD0850B3**  
Caglieron Caves  
Treviso, Italy





Olivia table lamp  
corten → **LD0850R3**  
A Cavalariça  
Évora, Portugal  
Photo Francisco Nogueira



Olivia mini table lamp orange → **LD0860Z3**  
Olivia mini table lamp Capri blue → **LD0860K3**  
Olivia mini table lamp apple green → **LD0860V3**



# Olivia

## Tavolo pro

Table lamp pro



Olivia è una lampada da tavolo a batteria, portatile e ricaricabile. Nella parte superiore della testa è presente un controllo "touch", che permette l'accensione, la regolazione dell'intensità luminosa e la selezione della temperatura di colore della luce tra 2700K e 3000K. Olivia possiede inoltre la funzione di memoria dell'impostazione di dimmerazione, che memorizza gli step di dimmerazione: di conseguenza, ad ogni accensione, l'intensità luminosa corrisponderà a quella precedentemente impostata. Grazie a un alto indice di protezione, la lampada è utilizzabile anche all'esterno (ad eccezione dei modelli con finitura a foglia metallica, delle quali è sconsigliato l'uso continuativo in esterni). È dotata di base di ricarica a contatto; caricabatterie incluso.

Olivia is a rechargeable battery-powered cordless table lamp. A "touch" control on the head allows switching on/off, dimming, and selecting the color temperature of the light (2700K or 3000K). Olivia is equipped with the dimmer memory function, which adjusts the light intensity and memorizes the dimmer steps; consequently, every time it is switched on, the light intensity will correspond to that previously set. It is suitable for both indoor and outdoor use (except gold, silver and copper finishes). The lamp comes with a contact charging base; battery charger included.



Olivia table lamp corten → LD0850R3

**Dati tecnici**

## Technical data

LED TOUCH DIMMER | 100-240V |  
2700-3000K | CRI>80 | 50-60Hz | 2,2W |  
245-262lm | **IP65** | 5Vdc max 1A



Corpo in pressofusione di alluminio verniciato

Painted die-cast aluminum body

Schermo diffusore in policarbonato prismatico

Prismatic polycarbonate diffuser

Adatta all'uso esterno (lampada IP65) e interno  
(lampada su base di ricarica IP20) → legenda pag. 208

Suitable for outdoor (lamp IP65) and indoor use  
(lamp on charging base IP20) → legend pg. 208

Durata di circa 9 h alla massima potenza

Battery lasts about 9 h at full power

Tempo di ricarica a 1A: 6 h

Charging time at 1A: 6 h

Pacco batteria al litio ricaricabile e sostituibile

Rechargeable and replaceable lithium battery pack

**Avvertenze**

## Remarks

Le lampade con finitura foglia color oro, foglia color argento e foglia color rame non sono adatte per uso esterno.

The lamps with gold color leaf, silver color leaf and copper color leaf finish are not suitable for outdoor use.

Per effetto della natura manuale della tecnica adottata nella lavorazione con foglia metallica, l'aspetto finale della finitura delle lampade può risultare differente. Eventuali difformità attestano il pregio e l'unicità di ciascuna lampada e non vanno considerate come imperfezioni.

Due to the manual nature of the technique adopted in the application of the metal foil, the final appearance of the lamps' finishing can be different. Any apparent imperfections attest to the quality and exclusivity of each lamp and should not be considered as imperfections.

Ø 11 cm  
Ø 4,3"

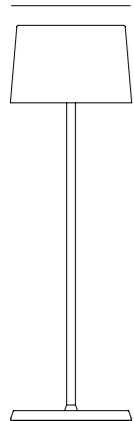

35 cm  
13,7"

Ø 11 cm  
Ø 4,3"

Ø 11,6 cm  
Ø 4,5"

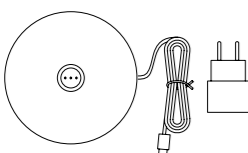
**Componenti inclusi**

## Components included

Base di ricarica a contatto

Contact charging base

Caricabatterie

Charger

**Finiture**

## Finishes

**LD0850B3**

Bianco / White  
RAL 9016

**LD0850R3**

Corten

**LD0850N3**

Grigio scuro / Dark grey  
RAL 7012

**LD0850BFO \***

Foglia color oro  
/ Gold color leaf

**LD0850BFA \***

Foglia color argento  
/ Silver color leaf

**LD0850RFR \***

Foglia color rame  
/ Copper color leaf

\* Le lampade con finitura foglia color oro, foglia color argento e foglia color rame non sono adatte per uso esterno.

\* The lamps with gold color leaf, silver color leaf and copper color leaf finish are not suitable for outdoor use.



# Olivia mini

## Tavolo pro

Table lamp pro



Olivia mini è una lampada da tavolo a batteria, portatile e ricaricabile. Nella parte superiore della testa è presente un controllo "touch", che permette l'accensione, la regolazione dell'intensità luminosa e la selezione della temperatura di colore della luce tra 2700K e 3000K. Olivia mini possiede inoltre la funzione di memoria dell'impostazione di dimmerazione, che memorizza gli step di dimmerazione: di conseguenza, ad ogni accensione, l'intensità luminosa corrisponderà a quella precedentemente impostata. Grazie a un alto indice di protezione, la lampada è utilizzabile anche all'esterno. È dotata di base di ricarica a contatto; caricabatterie incluso.

Olivia mini is a rechargeable battery-powered cordless table lamp. A "touch" control on the head allows switching on/off, dimming, and selecting the color temperature of the light (2700K or 3000K). Olivia mini is equipped with the dimmer memory function, which adjusts the light intensity and memorizes the dimmer steps; consequently, every time it is switched on, the light intensity will correspond to that previously set. It is suitable for both indoor and outdoor use. The lamp comes with a contact charging base; battery charger included.



Olivia mini table lamp corten  
→ **LD0860R3**

**Dati tecnici**

## Technical data

LED TOUCH DIMMER | 100-240V |  
2700-3000K | CRI>80 | 50-60Hz | 2,2W |  
245-262lm | **IP65** | 5Vdc max 1A



Corpo in pressofusione di alluminio verniciato  
Painted die-cast aluminum body

Schermo diffusore in policarbonato prismatico  
Prismatic polycarbonate diffuser

Adatta all'uso esterno (lampada IP65) e interno  
(lampada su base di ricarica IP20) → legenda pag. 208  
Suitable for outdoor (lamp IP65) and indoor use  
(lamp on charging base IP20) → legend pg. 208

Durata di circa 9 h alla massima potenza  
Battery lasts about 9 h at full power

Tempo di ricarica a 1A: 6 h  
Charging time at 1A: 6 h

Pacco batteria al litio ricaricabile e sostituibile  
Rechargeable and replaceable lithium battery pack

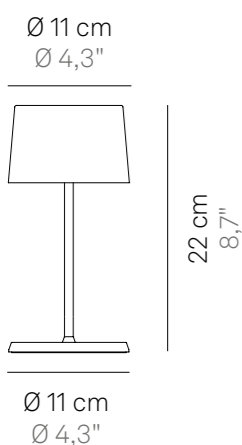

Ø 11,6 cm  
Ø 4,5"

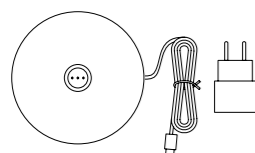
**Componenti inclusi**

## Components included

Base di ricarica a contatto  
Contact charging base

Caricabatterie  
Charger

**Finiture**

## Finishes



**LD0860B3**  
Bianco / White  
RAL 9016



**LD0860R3**  
Corten



**LD0860N3**  
Grigio scuro / Dark grey  
RAL 7012



**LD0860K3**  
Blu Capri / Capri blue  
RAL 5019



**LD0860L3**  
Lilla / Lilac  
RAL 4005



**LD0860V3**  
Verde mela / Apple green  
RAL 6018



**LD0860Z3**  
Arancio / Orange  
RAL 2008



# Pina

Piccola, docile  
mobile e leggera  
ti annidi e ti confondi.  
Gioca la luce  
offre dettagli dimenticati.

Small, gentle  
mobile and light  
you hide and blend in.  
Light brings playful effects  
offering forgotten details.

TAVOLO / SUPPORTO DA TERRA / VASSOIO IN CERAMICA  
TABLE LAMP / FLOOR STAND / CERAMIC TRAY



Pina table lamp white → **LD1650B3**  
Morgano countryside  
Treviso, Italy





Previous page: Pina table lamp corten →  
**LD1650R3**  
 Cipriani Club 55 - New York City, USA

Current page: Pina table lamp corten →  
**LD1650R3**  
 Cipriani Downtown - New York City, USA  
 Photo Kathi Littwin Photography

# Pina

## Tavolo pro Table lamp pro



Pina nel New York Times  
Pina in New York Times



Pina è una lampada da tavolo a batteria, portatile e ricaricabile. Sulla base è presente un controllo “touch”, che permette l'accensione, la regolazione dell'intensità luminosa e la selezione della temperatura di colore della luce tra 2200K, 2700K e 3000K. Grazie a un alto indice di protezione, la lampada è utilizzabile anche all'esterno (ad eccezione dei modelli con finitura a foglia metallica, delle quali è sconsigliato l'uso continuativo in esterni). Possiede un sistema di controllo elettronico che monitora e segnala l'autonomia residua della batteria, permettendo di ottimizzare le ricariche ed effettuarle sempre in maniera corretta. È dotata di base di ricarica a contatto; caricabatterie incluso. Pina è personalizzabile con il supporto da terra o con il vassoio in ceramica, acquistabili separatamente (pag.98 e pag. 102).

Pina is a rechargeable battery-powered cordless table lamp. A "touch" control on the head allows switching on/off, dimming, and selecting the color temperature of the light (2200 K, 2700 K or 3000 K). It is suitable for both indoor and outdoor use (except gold, silver and copper finishes). An electronic control system monitors the remaining autonomy and ensures a constant luminous flux until the battery runs out. Recharging is therefore optimized and always properly done. The lamp comes with a contact charging base; battery charger included. Pina can be accessorized with a floor stand or a ceramic tray, to be purchased separately (pg. 98 and pg.102).

Pina table lamp white  
→ LD1650B3





### Dati tecnici

#### Technical data

LED TOUCH DIMMER | 100-240V |  
2200-2700-3000K | CRI>80 | 50-60Hz |  
2,2W | 178-204-206lm | **IP54** | 5Vdc max 1A



Corpo in pressofusione di alluminio verniciato

Painted die-cast aluminum body

Schermo diffusore in policarbonato

Polycarbonate diffuser

Adatta all'uso esterno (lampada IP54) e interno  
(lampada su base di ricarica IP20) → legenda pag. 208

Suitable for outdoor (lamp IP54) and indoor use  
(lamp on charging base IP20) → legend pg. 208

Durata di circa 12 h alla massima potenza

Battery lasts about 12 h at full power

Tempo di ricarica a 1A: 6/7 h

Charging time at 1A: 6/7 h

Pacco batteria al litio ricaricabile e sostituibile

Rechargeable and replaceable lithium battery pack

#### Avvertenze

##### Remarks

Le lampade con finitura foglia color oro, foglia color argento e foglia color rame non sono adatte per uso esterno.

The lamps with gold color leaf, silver color leaf and copper color leaf finish are not suitable for outdoor use.

Per effetto della natura manuale della tecnica adottata nella lavorazione con foglia metallica, l'aspetto finale della finitura delle lampade può risultare differente. Eventuali difformità attestano il pregio e l'unicità di ciascuna lampada e non vanno considerate come imperfezioni.

Due to the manual nature of the technique adopted in the application of the metal foil, the final appearance of the lamps' finishing can be different. Any apparent imperfections attest to the quality and exclusivity of each lamp and should not be considered as imperfections.

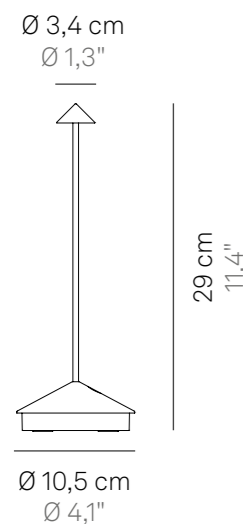

Ø 7,5 cm  
Ø 2,9"

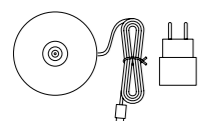

#### Componenti inclusi

##### Components included

Base di ricarica a contatto

Contact charging base

Caricabatterie

Charger

### Finiture

#### Finishes



##### LD1650B3

Bianco / White  
RAL 9003

##### LD1650R3

Corten

##### LD1650N3

Grigio scuro / Dark grey

##### LD1650D3

Nero / Black  
RAL 9004



##### LD1650S3

Sabbia / Sand  
RAL 1014



##### LD1650BFO \*

Foglia color oro  
/ Gold color leaf



##### LD1650BFA \*

Foglia color argento  
/ Silver color leaf



##### LD1650BFO \*

Foglia color rame  
/ Copper color leaf

\* Le lampade con finitura foglia color oro, foglia color argento e foglia color rame non sono adatte per uso esterno.

\* The lamps with gold color leaf, silver color leaf and copper color leaf finish are not suitable for outdoor use.

# Pina

## Supporto da terra

Floor stand



Video Pina



Supporto che trasforma la lampada da tavolo Pina in lampada con picchetto o lampada da terra. L'estremità inferiore del supporto si può montare secondo tre diverse configurazioni: solo con base; solo con picchetto; con picchetto e base, per aumentare la stabilità del supporto. La lampada Pina si alloggia esattamente nella parte superiore del supporto, senza agganciarsi, e può essere agilmente rimossa. Questo supporto non assolve la funzione di ricarica.

A floor stand that turns Pina into a floor lamp or a lamp with peg. The lower end of the stand can be mounted in three different configurations: with the base only, with the peg only, with both peg and base, to increase the stability of the stand. Pina lamp fits exactly in the upper part of the stand, without hooking for easy removal. The floor stand does not charge the lamp.



Pina table lamp sand + Pina floor stand sand  
→ LD1650S3 + LD0651S3



**Dati tecnici**

Technical data

Corpo in alluminio verniciato  
Painted aluminum body

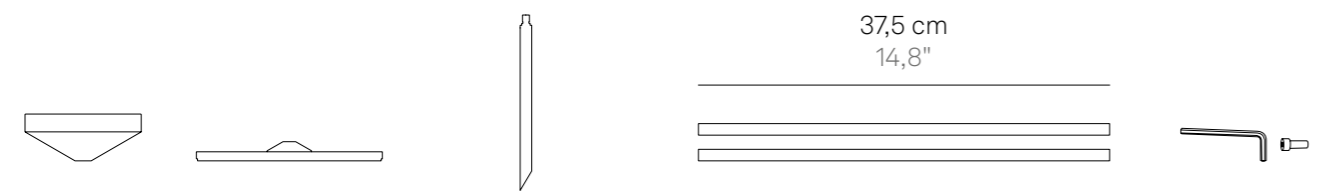
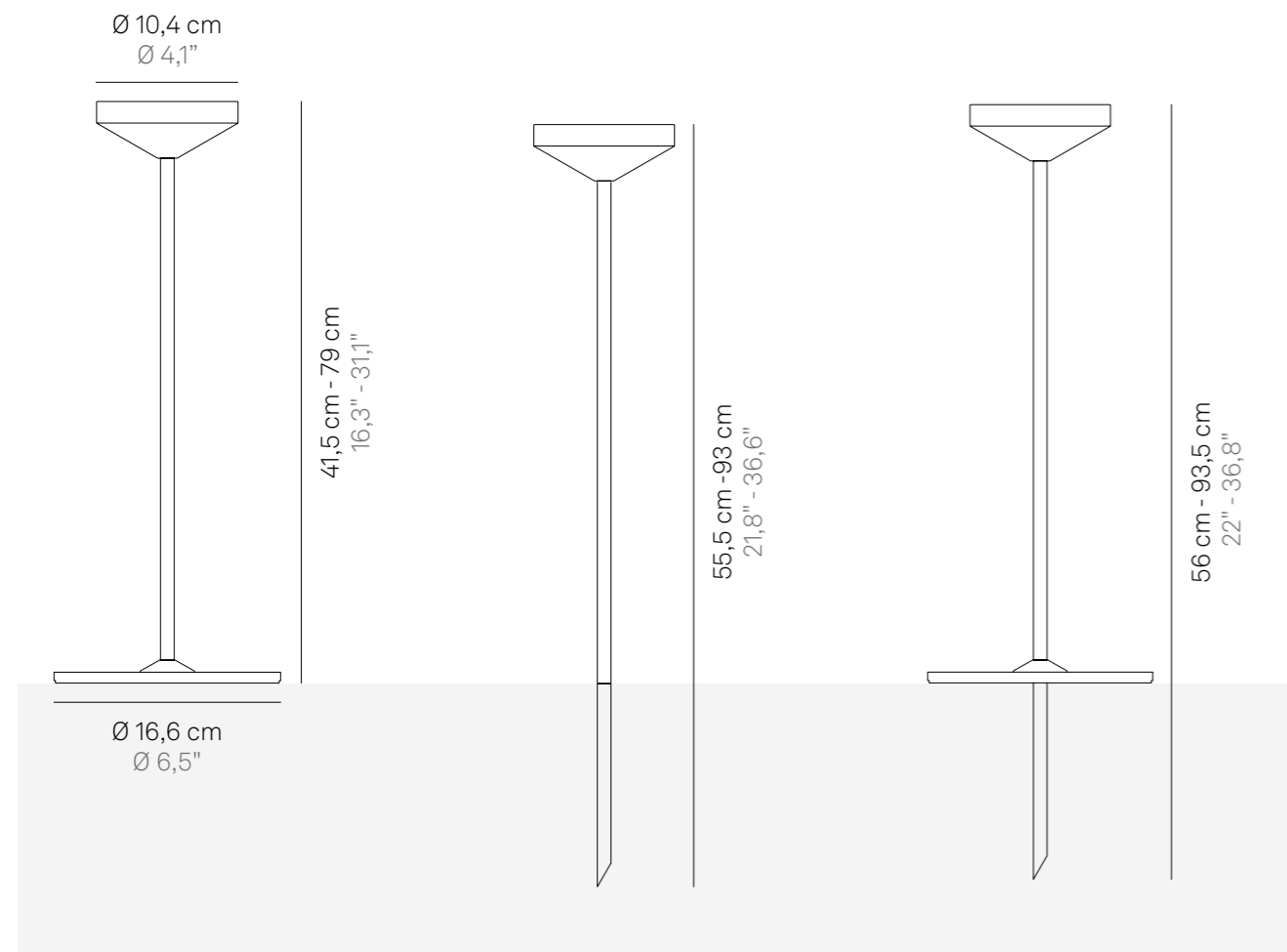

**Componenti inclusi**  
Components included

Base d'appoggio per lampada  
Housing for lamp

Base  
Base

Picchetto  
Peg

Stelo (2 pz.)  
Stem (2 pcs.)

Kit di assemblaggio  
Assembling kit



Pina table lamp white + Floor stand white  
→ **LD1650B3** + **LD0651B3**

**Finiture**

Finishes

- |                                                  |                           |                                                |                                                |                                     |
|--------------------------------------------------|---------------------------|------------------------------------------------|------------------------------------------------|-------------------------------------|
|                                                  |                           |                                                |                                                |                                     |
| <b>LD0651B3</b><br>Bianco<br>/ White<br>RAL 9003 | <b>LD0651R3</b><br>Corten | <b>LD0651N3</b><br>Grigio scuro<br>/ Dark grey | <b>LD0651D3</b><br>Nero<br>/ Black<br>RAL 9004 | <b>LD0651S3</b><br>Sabbia<br>/ Sand |



# Pina

## Vassoio in ceramica made in Italy

Ceramic tray made in Italy

NEW



### Dati tecnici

Technical data

CE

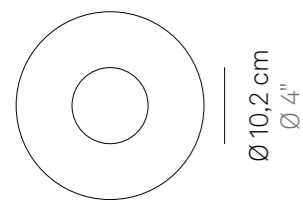

Ø 24,5 cm  
Ø 9,6"

Ø 10,2 cm  
Ø 4"

Vassoio in ceramica nella cui parte centrale concava, appositamente sagomata, si può alloggiare la lampada da tavolo Pina.

La stretta collaborazione con un'antica fabbrica di Civita Castellana - borgo viterbese dove l'arte della ceramica è attestata fin dal X secolo a.C. - consente a Zafferano di avvalersi di una produzione esclusiva di manufatti "Made in Italy", decorati a mano su disegno proprio.

Ceramic tray with a concave center that houses the base of Pina.

The close partnership with a historic factory in Civita Castellana - a village near Rome, where the art of ceramics has been practiced since the 10th century BC - allows Zafferano to rely on the exclusive production of made in Italy artifacts, which are hand-painted according to Zafferano design.

### Finiture

Finishes



#### LD065201

Bianco - Nero  
White - Black



#### LD065202

Blu notte - blu  
Navy blue - blue



#### LD065203

Sabbia - Azzurro  
Sand - Light blue







Pina table lamp corten +  
Ceramic tray sand - light blue  
→ **LD1650R3 + LD065203**



# Swap

Design Studio Kairos and Federico de Majo

Libellula ti muovi  
 Quasi invisibile  
 Diventi lucciola  
 Ci accudisci con una piccola luce  
 Vibrante di vetri e di raffinati veli  
 Trasformi per noi la tua essenza  
 E resti unica dolce compagna.

Dragonfly you move  
 Almost invisible  
 And become a firefly  
 Watching over us with a small light  
 Shimmering with glass and refined veils  
 You transform your essence for us  
 And remain the only sweet companion.

TAVOLO / ACCESSORI / MINI TAVOLO / ACCESSORI  
 TABLE LAMP/ ACCESSORIES / MINI TABLE LAMP / ACCESSORIES



Swap table lamp white → **LD1010B3**  
 Swap mini table lamp white → **LD1011B3**  
 Cansiglio forest  
 Treviso, Italy



# Swap

## Tavolo pro

Table lamp pro



Swap è una lampada da tavolo a batteria, portatile e ricaricabile. Sulla base è presente un controllo "touch", che permette l'accensione e la regolazione dell'intensità luminosa. Grazie a un alto indice di protezione, la lampada è utilizzabile anche all'esterno. Possiede un sistema di controllo elettronico che monitora e segnala l'autonomia residua della batteria, permettendo di ottimizzare le ricariche ed effettuarle sempre in maniera corretta. È dotata di base di ricarica a contatto; caricabatterie incluso. Swap è personalizzabile con paralumi in vetro, ceramica o tessuto, acquistabili separatamente (pag. 114-116-118).

Swap is a rechargeable battery-powered cordless table lamp. A "touch" control on the base allows switching on/off and dimming. It is suitable for both indoor and outdoor use. An electronic control system monitors the remaining autonomy and ensures a constant luminous flux until the battery runs out. Recharging is therefore optimized and always properly done. The lamp comes with a contact charging base; battery charger included. Swap can be customized with glass, ceramic, or fabric lampshades, to be purchased separately (pg. 114-116-118).



Swap table lamp corten  
→ LD1010R3



Swap table lamp black + fabric lampshade black  
→ **LD1010N3 + LD102005**



Swap table lamp white + glass lampshade  
→ **LD1010B3 + LD102004**



**Dati tecnici**

## Technical data

LED TOUCH DIMMER | 100-240V |  
2700K | CRI>90 | 50-60Hz | 2W | 267lm |  
**IP65** | 5Vdc max 1A

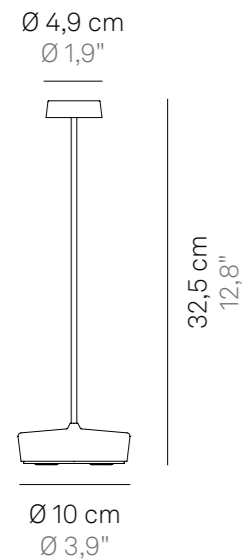

Corpo in pressofusione di alluminio verniciato  
Painted die-cast aluminum body

Schermo diffusore in policarbonato  
Polycarbonate diffuser

Adatta all'uso esterno (lampada IP65) e interno  
(lampada su base di ricarica IP20) → legenda pag. 208  
Suitable for outdoor (lamp IP65) and indoor use  
(lamp on charging base IP20) → legend pg. 208

Durata di circa 13 h alla massima potenza  
Battery lasts about 13 h at full power

Tempo di ricarica a 1A: 6 h  
Charging time at 1A: 6 h

Pacco batteria al litio ricaricabile e sostituibile  
Rechargeable and replaceable lithium battery pack

Ø 7,5 cm  
Ø 2,9"

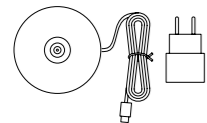
**Componenti inclusi**

## Components included

Base di ricarica a contatto  
Contact charging base

Caricabatterie  
Charger

**Finiture**

## Finishes



**LD1010B3**  
Bianco / White  
RAL 9002

**LD1010R3**  
Corten

**LD1010N3**  
Nero / Black  
RAL 9005

# Swap

## Paralume in tessuto

Fabric lampshade



### Finiture

Finishes



**LD102000**

Bianco / White

**LD102005**

Nero / Black

### Dati tecnici

Technical data

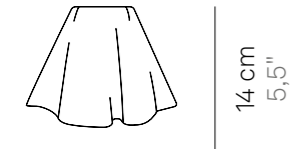

Ø 15 cm  
Ø 5,9"

**Componenti inclusi**  
Components included

Magnete e dima  
Magnet and cut-out

**Video tutorial:** montaggio paralume  
Tutorial video: installation of the lampshade



Paralume morbido in tessuto elastico ignifugo, lavabile e ingualcibile, con dischetto in policarbonato e orlo sopraffilato, che si fissa alla testa di Swap tramite un magnete.

A soft lampshade made of fire-retardant elastic fabric, which is washable and crease-resistant, with a polycarbonate disc and a zig-zag edging, that is fixed to the head of the lamp with a magnet.





# Swap

## Paralume in vetro

Glass lampshade



### Dati tecnici

Technical data

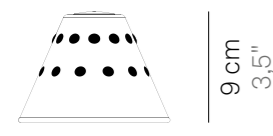

Ø 13 cm  
Ø 5,1"

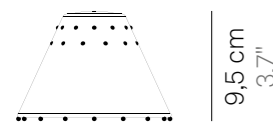

Ø 13 cm  
Ø 5,1"

### Componenti inclusi

Components included

Magnete e dima  
Magnet and cut-out

Video tutorial: montaggio paralume  
Tutorial video: installation of the lampshade



Paralume in vetro borosilicato soffiato e lavorato a mano con decorazioni a rilievo, che si fissa alla testa di Swap tramite un magnete.

A handcrafted, blown borosilicate glass lampshade, with relief decorations, that is fixed to the head of the lamp with a magnet.

### Finiture

Finishes



**LD102001**  
Bianco / White



**LD102002**  
Nero / Black



**LD102003**  
Ambra / Amber



**LD102004**  
Blu / Blue



**LD102011**  
Bianco / White



**LD102012**  
Nero / Black



**LD102013**  
Ambra / Amber



**LD102014**  
Blu / Blue



# Swap

## Paralume in ceramica made in Italy

Ceramic lampshade  
made in Italy

NEW



### Dati tecnici

Technical data

CE

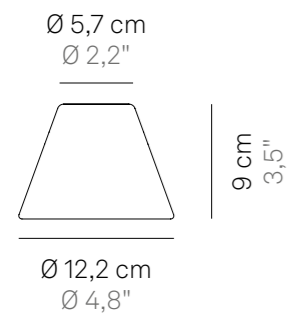

### Componenti inclusi

Components included

Magnete e dima  
Magnet and cut-out

Video tutorial: montaggio paralume  
Tutorial video: installation of the lampshade



Paralume in ceramica che si fissa alla testa di Swap tramite un magnete.

La stretta collaborazione con un'antica fabbrica di Civita Castellana - borgo viterbese dove l'arte della ceramica è attestata fin dal X secolo a.C. - consente a Zafferano di avvalersi di una produzione esclusiva di manufatti "Made in Italy", decorati a mano su disegno proprio o del cliente.

Ceramic lampshade that is fixed to the head of the lamp with a magnet.

The close partnership with a historic factory in Civita Castellana - a village near Rome, where the art of ceramics has been practiced since the 10th century BC - allows Zafferano to rely on the exclusive production of made in Italy artifacts, which are hand-painted according to Zafferano design; customization available.

### Finiture

Finishes



**LD102101**  
Bianco - Nero  
/ White - Black



**LD102103**  
Sabbia - Azzurro  
/ Sand - Light blue





# Swap mini

## Tavolo pro

Table lamp pro



Swap mini è una lampada da tavolo a batteria, portatile e ricaricabile. Sulla base è presente un controllo "touch", che permette l'accensione e la regolazione dell'intensità luminosa. Grazie a un alto indice di protezione, la lampada è utilizzabile anche all'esterno (ad eccezione dei modelli con finitura galvanica, delle quali è sconsigliato l'uso continuativo in esterni). Possiede un sistema di controllo elettronico che monitora e segnala l'autonomia residua della batteria, permettendo di ottimizzare le ricariche ed effettuarle sempre in maniera corretta. È dotata di base di ricarica a contatto; caricabatterie non incluso. È possibile personalizzare la lampada con paralumi in ceramica, acquistabili separatamente

Swap mini is a rechargeable battery-powered cordless table lamp. A "touch" control on the base allows switching on/off and dimming. It is suitable for both indoor and outdoor use (except gold and silver finishes). An electronic control system monitors the remaining autonomy and ensures a constant luminous flux until the battery runs out. Recharging is therefore optimized and always properly done. The lamp comes with a contact charging base; the battery charger is not included. Swap mini can be customized choosing from a range of ceramic lampshades, to be purchased separately



Swap mini table lamp white  
→ LD1011B3



Swap mini table lamp  
Capri blue → **LD1011K3**



Swap mini table lamp corten  
+ ceramic lampshade sand-light blue  
→ **LD1011R3 + LD101103**



**Dati tecnici**

## Technical data

LED TOUCH DIMMER | 2700K | CRI>90 |  
2W | 267lm | **IP65** | 5 Vdc max 1A



Corpo in pressofusione di alluminio verniciato  
Painted die-cast aluminum body

Schermo diffusore in policarbonato  
Polycarbonate diffuser

Adatta all'uso esterno (lampada IP65) e interno  
(lampada su base di ricarica IP20) → legenda pag. 208  
Suitable for outdoor (lamp IP65) and indoor use  
(lamp on charging base IP20) → legend pg. 208

Durata di circa 13 h alla massima potenza  
Battery lasts about 13 h at full power

Tempo di ricarica a 1A: 6 h  
Charging time at 1A: 6 h

Pacco batteria al litio ricaricabile e sostituibile  
Rechargeable and replaceable lithium battery pack

#### Avvertenze

Remarks

Le lampade con finitura galvanica lucida oro e cromo non sono adatte per uso esterno.  
The lamps with gold and chrome glossy galvanic finish are not suitable for outdoor use.

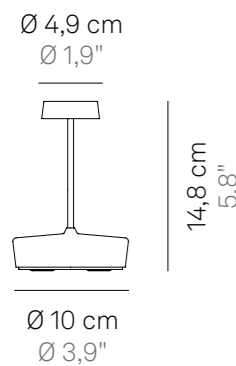

Ø 7,5 cm  
Ø 2,9"

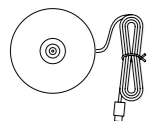
**Componenti inclusi**

Components included

Base di ricarica a contatto  
Contact charging base

**Accessori non inclusi**

Accessories not included

Caricabatterie → pag. 199  
Charger → pg. 199

**Finiture**

## Finishes



**LD1011B3**  
Bianco / White  
RAL 9002



**LD1011R3**  
Corten



**LD1011N3**  
Nero / Black  
RAL 9005



**LD1011O3 \***  
Oro lucido  
/ Glossy gold



**LD1011C3 \***  
Cromo lucido  
/ Glossy chrome



**LD1011K3**  
Blu Capri  
/ Capri blue  
RAL 5019



**LD1011L3**  
Lilla / Lilac  
RAL 4005



**LD1011V3**  
Verde mela  
/ Apple green  
RAL 6018



**LD1011Z3**  
Arancio / Orange  
RAL 2008

\* Le lampade con finitura galvanica lucida oro e cromo non sono adatte per uso esterno.  
\* The lamps with gold and chrome glossy galvanic finish are not suitable for outdoor use.

# Swap mini

## Paralume in ceramica made in Italy

Ceramic lampshade  
made in Italy



NEW

### Dati tecnici

Technical data

CE

Ø 5,7 cm  
Ø 2,2"

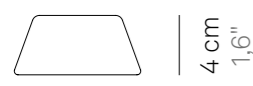

Ø 8,5 cm  
Ø 3,3"

### Componenti inclusi Components included

Magnete e dima  
Magnet and cut-out

Video tutorial: montaggio paralume  
Tutorial video: installation of the lampshade



Paralume in ceramica che si fissa alla testa di Swap mini tramite un magnete.

La stretta collaborazione con un'antica fabbrica di Civita Castellana - borgo viterbese dove l'arte della ceramica è attestata fin dal X secolo a.C. - consente a Zafferano di avvalersi di una produzione esclusiva di manufatti "Made in Italy", decorati a mano su disegno proprio o del cliente.

Ceramic lampshade that is fixed to the head of the lamp with a magnet.

The close partnership with a historic factory in Civita Castellana - a village near Rome, where the art of ceramics has been practiced since the 10th century BC - allows Zafferano to rely on the exclusive production of made in Italy artifacts, which are hand-painted according to Zafferano design; customization available.

### Finiture

Finishes



**LD101101**  
Bianco - Nero  
/ White - Black



**LD101102**  
Blu notte - Blu  
/ Navy blue - Blue



**LD101103**  
Sabbia - Azzurro  
/ Sand - Light blue



**LD101104**  
Pesci azzurri  
/ Light blue fish



**LD101105**  
Pois verdi  
/ Green dots



**LD101106**  
Pois arancio  
/ Orange dots



**LD101107**  
Pois azzurri  
/ Light blue dots



**LD101108**  
Pois rosso  
/ Red dots



**LD101109**  
Pois neri  
/ Black dots



# Push-up

Cuore di luce  
Animo forte  
Ti apri come madreperla  
Donando un immediato piacere  
Una inaspettata luminosità.

Heart of light  
Powerful spirit  
You open like a mother-of-pearl shell  
Giving instant pleasure,  
Unexpected luminosity.

TAVOLO  
TABLE LAMP



Push-up table lamp corten → **LD1050R3**  
Padua, Italy

# Push-up

## Tavolo pro Table lamp pro

NEW



Video Push-up



Push-up è una lampada da tavolo a batteria, portatile e ricaricabile. Premendo la parte superiore della lampada, questa si solleva e contemporaneamente si accende; premendo nuovamente fino alla chiusura, la lampada si spegne. Sotto la base è presente un controllo "touch", che – quando la parte superiore della lampada è sollevata – permette lo spegnimento, la regolazione dell'intensità luminosa e la selezione della temperatura di colore della luce tra 2200K, 2700K e 3000K. Grazie a un alto indice di protezione, la lampada è utilizzabile anche all'esterno. Possiede un sistema di controllo elettronico che monitora e segnala l'autonomia residua della batteria, permettendo di ottimizzare le ricariche ed effettuarle sempre in maniera corretta. È dotata di base di ricarica a contatto; caricabatterie non incluso.

Push-up is a rechargeable battery-powered cordless table lamp. Pushing the lid down, lifts the diffuser up and turns the light on; pushing the lid back down, closes the lamp while turning the light off. A "touch" control hidden under the base allows switching on/off, dimming, and selecting the color temperature of the light (2200K, 2700K or 3000K). It is suitable for both indoor and outdoor use. An electronic control system monitors the remaining autonomy and ensures a constant luminous flux until the battery runs out. Recharging is therefore optimized and always properly done. The lamp comes with a contact charging base; the battery charger is not included.

Push-up table lamp  
white → **LD1050B3**

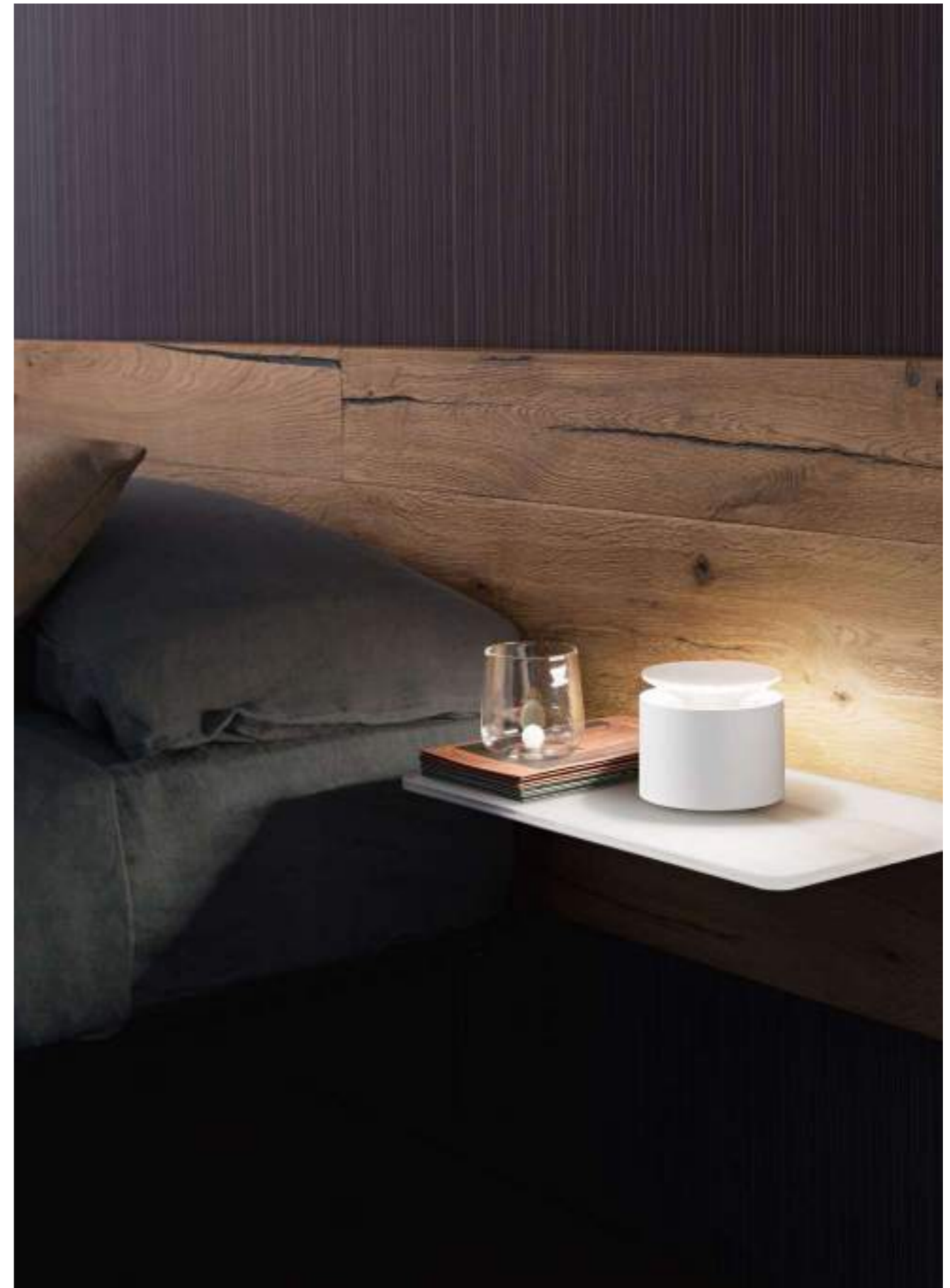



**Dati tecnici**

## Technical data

LED TOUCH DIMMER | 2200-2700-  
3000K | CRI>80 | 2,2W | 207-235-248lm |  
**IP54** | 5 Vdc max 1A

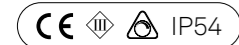

Corpo in pressofusione di alluminio verniciato  
Painted die-cast aluminum body

Schermo diffusore in policarbonato  
Polycarbonate diffuser

Adatta all'uso esterno (lampada IP54) e interno  
(lampada su base di ricarica IP20) → legenda pag. 208  
Suitable for outdoor (lamp IP54) and indoor use  
(lamp on charging base IP20) → legend pg. 208

Durata di circa 11/12 h alla massima potenza  
Battery lasts about 11/12 h at full power

Tempo di ricarica a 1A: 5/6 h  
Charging time at 1A: 5/6 h

Pacco batteria al litio ricaricabile e sostituibile  
Rechargeable and replaceable lithium battery pack

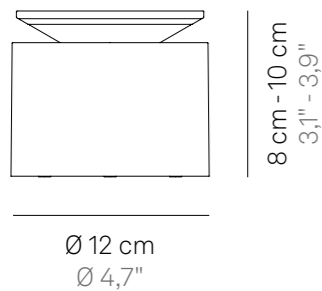

Ø 10 cm  
Ø 3,9"

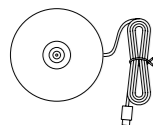
**Componenti inclusi**

Components included

Base di ricarica a contatto  
Contact charging base

**Accessori non inclusi**

Accessories not included

Caricabatterie → pag. 199  
Charger → pg. 199

**Finiture**

## Finishes



**LD1050B3**  
Bianco / White  
RAL 9003



**LD1050R3**  
Corten



**LD1050N3**  
Grigio scuro / Dark grey



**LD1050S3**  
Sabbia / Sand



Push-up table lamp dark grey → **LD1050N3**  
Push-up table lamp corten → **LD1050R3**

# Home

Voglio una casa illuminata  
 Tanto grande e tanto piccola  
 Come la penso ogni giorno  
 Con tanti o pochi amici  
 Vere presenze  
 Penso la casa sul mare e sulla sabbia  
 Sul prato ombreggiato dal tiglio  
 E sulla montagna dopo il tramonto  
 Che racconta dei nostri tanti passi.

I'd like a bright house  
 As large and as small  
 As I imagine it every day  
 With many or a few friends  
 True presences  
 I imagine a house by the sea and on the sand  
 On the lawn, in the shade of a linden tree  
 And in the mountains after sunset  
 That reveals our many steps.

TAVOLO / SUPPORTO PARETE  
 TABLE LAMP / WALL LAMP KIT



Home table lamp white → **LD0258B3**  
 Home table lamp dark grey → **LD0258N3**

Euganean hills  
 Padua, Italy



# Home

## Tavolo pro Table lamp pro



Home è una lampada da tavolo a batteria, portatile e ricaricabile. Sulla base è presente un controllo "touch", che permette l'accensione e la regolazione dell'intensità luminosa. Grazie a un alto indice di protezione, la lampada è utilizzabile anche all'esterno. Possiede un sistema di controllo elettronico che monitora e segnala l'autonomia residua della batteria, permettendo di ottimizzare le ricariche ed effettuarle sempre in maniera corretta. È dotata di base di ricarica a contatto; caricabatterie incluso. Home può diventare una lampada da parete tramite l'apposito accessorio, acquistabile separatamente (pag. 140).

Home is a rechargeable battery-powered cordless table lamp. A "touch" control on the base allows switching on/off and dimming. It is suitable for both indoor and outdoor use. An electronic control system monitors the remaining autonomy and ensures a constant luminous flux until the battery runs out. Recharging is therefore optimized and always properly done. The lamp comes with a contact charging base; the battery charger is included. Home can become a wall lamp thanks its dedicated accessory, to be purchased separately (pg. 140).

Home table lamp white  
→ LD0258B3



**Dati tecnici**

## Technical data

LED TOUCH DIMMER | 100-240V |  
3000K | CRI>80 | 50-60Hz | 2,2W |  
260lm | **IP54** | 5Vdc max 1A



Corpo in pressofusione di alluminio verniciato  
Painted die-cast aluminum body

Schermo diffusore in policarbonato  
Polycarbonate diffuser

Adatta all'uso esterno (lampada IP54) e interno  
(lampada su base di ricarica IP20) → legenda pag. 208  
Suitable for outdoor (lamp IP54) and indoor use  
(lamp on charging base IP20) → legend pg. 208

Durata di circa 12 h alla massima potenza  
Battery lasts about 12 h at full power

Tempo di ricarica a 1A: 6/8 h  
Charging time at 1A: 6/8 h

Pacco batteria al litio ricaricabile e sostituibile  
Rechargeable and replaceable lithium battery pack



10 x 10 cm  
3,9" x 3,9"

Ø 7,5 cm  
Ø 2,9"

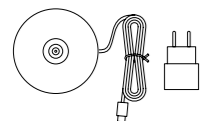
**Componenti inclusi**

## Components included

Base di ricarica a contatto  
Contact charging base

Caricabatterie  
Charger

**Finiture**

## Finishes



**LD0258B3**  
Bianco / White  
RAL 9003



**LD0258R3**  
Corten



**LD0258N3**  
Grigio scuro / Dark grey



# Home

## Supporto parete Wall lamp kit

NEW



### Dati tecnici Technical data

CE

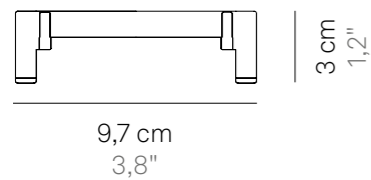

### Finiture Finishes



**LD0259B3**  
Bianco  
/ White  
RAL 9003



**LD0259R3**  
Corten



**LD0259N3**  
Grigio scuro  
/ Dark grey

Supporto in pressofusione d'alluminio verniciato  
Painted die-cast aluminum element



A wall bracket that turns Home into a wall lamp. The lamp can be used in its fixed housing or detached and carried from one place to another.

Supporto che trasforma la lampada da tavolo Home in lampada da parete. La lampada può essere usata nel suo supporto fisso, ma anche rimossa e portata con sé da un ambiente all'altro.

Home table lamp white  
+ Home wall lamp kit white  
→ **LD0258B3** + **LD0259B3**

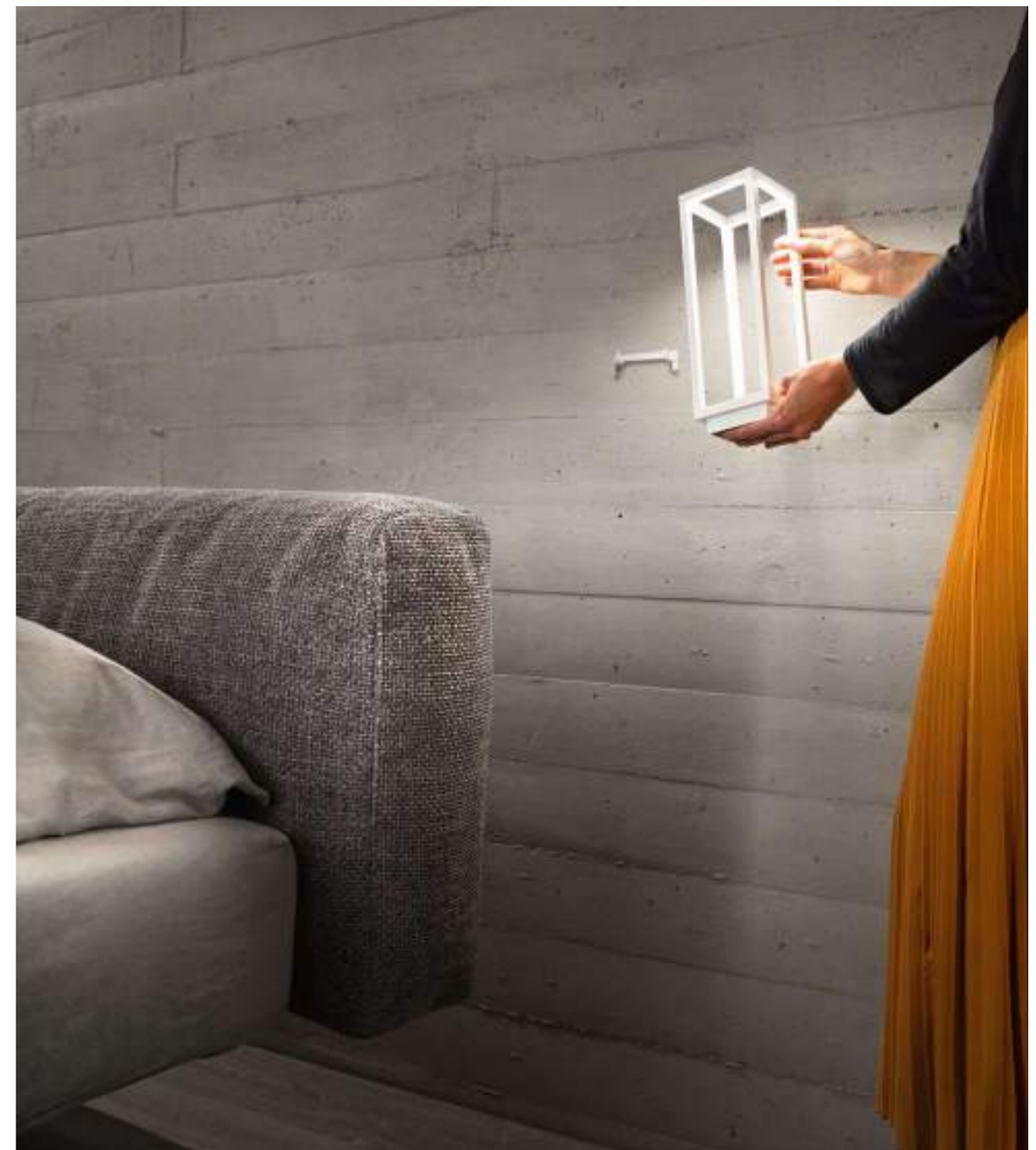

# Dama

A stone shines  
light awakens it  
while a small moon  
radiates a faint yet vibrant glow.  
The endless passage of much water  
has patiently smoothed it.

Un sasso risplende  
la luce lo risveglia  
mentre una piccola luna  
emana un chiarore flebile ma vivo.  
È il passaggio perpetuo di tanta acqua  
che paziente lo ha levigato.

TAVOLO  
TABLE LAMP



Dama table lamp white  
→ **LD0610B3**  
Piave riverbed  
Treviso, Italy



# Dama

## Tavolo pro Table lamp pro



Dama table lamp white  
→ LD0610B3

Dama è una lampada da tavolo a batteria, portatile e ricaricabile. Nella parte superiore della testa è presente un controllo "touch", che permette l'accensione, la regolazione dell'intensità luminosa e la selezione della temperatura di colore della luce tra 2200K, 2700K e 3000K. Grazie a un alto indice di protezione, la lampada è utilizzabile anche all'esterno. Possiede un sistema di controllo elettronico che monitora e segnala l'autonomia residua della batteria, permettendo di ottimizzare le ricariche ed effettuarle sempre in maniera corretta. È dotata di base di ricarica a contatto; caricabatterie incluso.

Dama is a rechargeable battery-powered cordless table lamp. A "touch" control on the head allows switching on/off, dimming, and selecting the color temperature of the light (2200K, 2700K or 3000K). It is suitable for both indoor and outdoor use. An electronic control system monitors the remaining autonomy and ensures a constant luminous flux until the battery runs out. Recharging is therefore optimized and always properly done. The lamp comes with a contact charging base; the battery charger is included.



**Dati tecnici**

## Technical data

LED TOUCH DIMMER | 100-240V | 2200-2700-3000K | CRI>80 | 50-60Hz | 2,2W | 194-219-221lm | **IP54** | 5Vdc max 1A

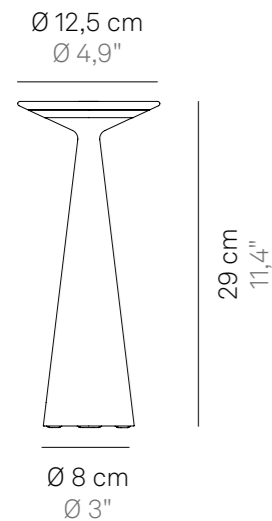

Ø 7,5 cm  
Ø 2,9"

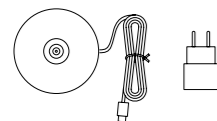

Corpo in pressofusione di alluminio verniciato  
Painted die-cast aluminum body

Schermo diffusore in policarbonato  
Polycarbonate diffuser

Adatta all'uso esterno (lampada IP54) e interno (lampada su base di ricarica IP20) → legenda pag. 208  
Suitable for outdoor (lamp IP54) and indoor use (lamp on charging base IP20) → legend pg. 208

Durata di circa 9 h alla massima potenza  
Battery lasts about 9 h at full power

Tempo di ricarica a 1A: 6 h  
Charging time at 1A: 6 h

Pacco batteria al litio ricaricabile e sostituibile  
Rechargeable and replaceable lithium battery pack

**Componenti inclusi**

## Components included

Base di ricarica a contatto  
Contact charging base

Caricabatterie  
Charger

**Finiture**

## Finishes



**LD0610B3**  
Bianco / White  
RAL 9003

**LD0610N3**  
Nero opaco / Black  
RAL 9004



Dama table lamp white  
→ **LD0610B3**  
Ristorante Le Lampare  
al Fortino - Trani, Italy  
Photo Vito Rizzi Photographer



# Olimpia

Design Federico de Majo

Luna luminosa, piena  
la tua luce  
penetra nei solchi, negli anfratti.  
Gradino dopo gradino  
ci avviciniamo.

Bright full moon  
your light  
penetrates furrows and crevices.  
Step by step  
we draw near.

TAVOLO  
TABLE LAMP



Olimpia table lamp  
white → **LD0900B3**  
Brent de l'Art  
Belluno, Italy

# Olimpia

## Tavolo pro Table lamp pro



Olimpia è una lampada da tavolo a batteria, portatile e ricaricabile. Sulla base è presente un controllo "touch", che permette l'accensione e la regolazione dell'intensità luminosa. Grazie a un alto indice di protezione, la lampada è utilizzabile anche all'esterno (ad eccezione dei modelli con finitura galvanica, delle quali è sconsigliato l'uso continuativo in esterni). È possibile rendere più caldo il colore della luce, sostituendo il filtro già presente sulla sorgente luminosa con quello color ambra (fornito in dotazione). È dotata di base di ricarica a contatto; caricabatterie incluso.

Olimpia is a rechargeable battery-powered cordless table lamp. A "touch" control on the base allows switching on/off and dimming. It is suitable for both indoor and outdoor use (except gold and silver finishes). The color temperature of the light can be changed to warmer by swapping the filter onboard with the amber one (included). The lamp comes with a contact charging base; the battery charger is included.

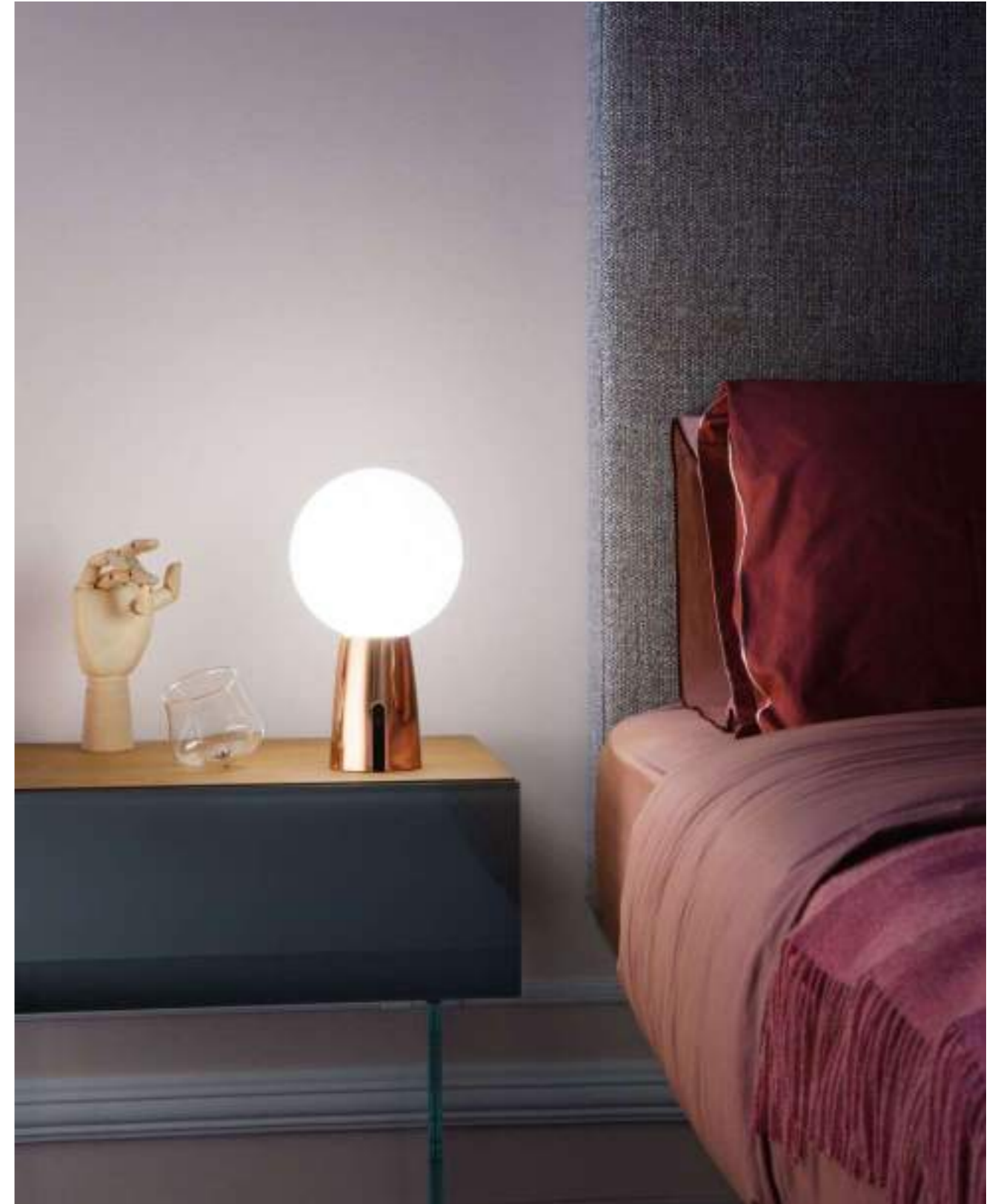

Olimpia table lamp copper  
→ LD0900E3



**Dati tecnici**

## Technical data

LED TOUCH DIMMER | 100-240V |  
3000K | CRI>80 | 50-60Hz | 2,5W |  
268lm | **IP54** | 5Vdc max 1A



Corpo in pressofusione di alluminio verniciato  
Painted die-cast aluminum body

Schermo diffusore in policarbonato  
Polycarbonate diffuser

Adatta all'uso esterno (lampada IP54) e interno  
(lampada su base di ricarica IP20) → legenda pag. 208  
Suitable for outdoor (lamp IP54) and indoor use  
(lamp on charging base IP20) → legend pg. 208

Durata di circa 9 h alla massima potenza  
Battery lasts about 9 h at full power

Tempo di ricarica a 1A: 9 h  
Charging time at 1A: 9 h

Pacco batteria al litio ricaricabile e sostituibile  
Rechargeable and replaceable lithium battery pack

**Avvertenze**

## Remarks

Le lampade con finitura oro, cromo e rame  
non sono adatte per uso esterno.  
The lamps with gold, chrome and silver finish  
are not suitable for outdoor use.

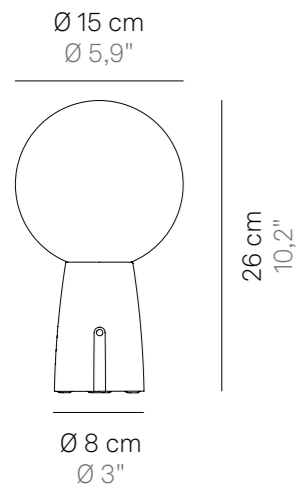

Ø 7,5 cm  
Ø 2,9"

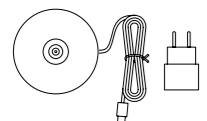

Ø 3,3 cm  
Ø 1,3"

**Componenti inclusi**

## Components included

Base di ricarica a contatto  
Contact charging base

Caricabatterie  
Charger

Filtro  
Lens

**Finiture**

## Finishes



**LD0900B3**  
Bianco / White  
RAL 9003



**LD0900N3**  
Grigio scuro / Dark grey



**LD0900O3 \***  
Oro lucido / Glossy gold



**LD0900C3 \***  
Cromo lucido / Glossy  
chrome



**LD0900E3 \***  
Rame lucido  
/Glossy copper

\* Le lampade con finitura color oro, cromo e rame non sono adatte per uso esterno.  
\* The lamps with gold, chromo and copper finish are not suitable for outdoor use.

# Sister Light

Design Federico de Majo

An enchanted forest  
rich in greenery  
and glowing mushrooms.  
Eyes of elves, hidden  
spy on your many powers.

Un bosco incantato  
ricco di vegetazione  
e funghi fosforescenti.  
Occhi di elfi, nascosti  
spiano le tue molteplici abilità.

TAVOLO / MINI TAVOLO / PICCHETTO / PARETE  
TABLE LAMP / MINI TABLE LAMP / LAMP WITH PEG / WALL LAMP



Sister Light table lamp gold → **LD030003**  
Sister Light mini table lamp gold → **LD030603**  
Rosoline pine forest  
Rovigo, Italy





Sister Light table lamp  
copper → **LD0300R3**  
42 Restaurant & Bar  
Esztergom, Hungary  
Photo Patrik Fábian





# Sister Light

## Tavolo

Table lamp



Sister Light è una lampada da tavolo a batteria, portatile e ricaricabile. Nella parte superiore della testa è presente un controllo "touch" che permette l'accensione, la regolazione dell'intensità luminosa (dimmerazione a 4 step) e la selezione della temperatura di colore della luce tra 2700K, 3150K e 4000K. Grazie a un alto indice di protezione, la lampada è utilizzabile anche all'esterno; resiste inoltre alla nebbia salina (1500 h). La testa della lampada, avvitata sullo stelo, è convertibile a fissaggio magnetico e dunque può essere separata per diventare una fonte luminosa di emergenza. La base della lampada è predisposta per il fissaggio meccanico al tavolo. Possiede un sistema di controllo elettronico che monitora l'autonomia residua e garantisce un flusso luminoso costante fino all'esaurimento della batteria, permettendo di ottimizzare le ricariche ed effettuarle sempre in maniera corretta. È dotata di cavo USB Type-C per la ricarica; caricabatterie non incluso.

Sister Light is a rechargeable battery-powered cordless table lamp. A "touch" control on the head allows switching on, dimming (4-step: 100%, 60%, 30%, 6%) and selecting the color temperature of the light (2700K, 3150K or 4000K). It is suitable for both indoor and outdoor use and salt spray resistant (1500 h). The head of the lamp comes screwed to the stem; it can be converted to magnetic fixing and detached to become an emergency light. The base of the lamp is designed to be mechanically fixed to a table. An electronic control system monitors the remaining autonomy and ensures a constant luminous flux until the battery runs out. Recharging is therefore optimized and always properly done. The lamp comes with a USB Type-C cable for recharging; the battery charger is not included.



Sister Light table lamp blue  
→ LD0300B3



**Dati tecnici**

## Technical data

LED TOUCH DIMMER | 2700-3150-4000K | CRI>90 | 3W | 305-326-328lm |  
**IP65** | 5 Vdc max 2A

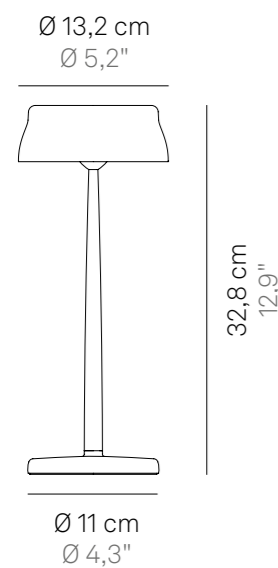

Corpo in alluminio anodizzato spazzolato  
 Brushed anodized aluminum body

Diffusore in policarbonato prismatico  
 Prismatic polycarbonate diffuser

Adatta all'uso esterno (lampada IP65) e interno (lampada su base di ricarica IP20) → legenda pag. 208  
 Suitable for outdoor (lamp IP65) and indoor use (lamp on charging base IP20) → legend pg. 208

Resistenza agli urti (IK07) e alla nebbia salina (1500h)  
 Impact resistance (IK07) and salt spray resistance (1500h)

Durata 8 - 58 h, in base alla regolazione del flusso luminoso  
 Battery lasts 8 - 58 h, depending on the luminous flux setting.

Tempo di ricarica a 2A: circa 5 h  
 Charging time at 2A: about 5 h

Ricarica con cavetto USB-c  
 Rechargeable with a USB-c cable

Pacco batteria al litio ricaricabile e sostituibile  
 Rechargeable and replaceable lithium battery pack

**Finiture**

## Finishes



**LD030003**  
 Oro / Gold



**LD0300A3**  
 Alluminio / Aluminum



**LD0300R3**  
 Rame / Copper



**LD0300V3**  
 Verde / Green



**LD0300B3**  
 Blu / Blue

**Componenti inclusi**

## Components included

Cavo di ricarica con entrata USB-c  
 Charging cable with USB-c input

Kit per fissaggio magnetico  
 Kit for magnetic fixing

Kit per fissaggio meccanico al tavolo  
 Kit for mechanical fixing to a table

**Componente non incluso**

## Component not included

Caricabatterie 5Vdc max 2,1A \* → pag. 199  
 Charger 5Vdc max 2,1A \* → pg. 199

\* Componente necessario, da acquistare separatamente

\* Necessary component, yet it must be purchased separately

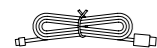

# Sister Light mini

## Tavolo

### Table lamp



Sister Light mini è una lampada da tavolo a batteria, portatile e ricaricabile. Nella parte superiore della testa è presente un controllo “touch” che permette l'accensione, la regolazione dell'intensità luminosa (dimmerazione a 4 step) e la selezione della temperatura di colore della luce tra 2700K, 3150K e 4000K. Grazie a un alto indice di protezione, la lampada è utilizzabile anche all'esterno; resiste inoltre alla nebbia salina (1500 h). La testa della lampada, avvitata sullo stelo, è convertibile a fissaggio magnetico e dunque può essere separata per diventare una fonte luminosa di emergenza. La base della lampada è predisposta per il fissaggio meccanico al tavolo. Possiede un sistema di controllo elettronico che monitora l'autonomia residua e garantisce un flusso luminoso costante fino all'esaurimento della batteria, permettendo di ottimizzare le ricariche ed effettuarle sempre in maniera corretta. È dotata di cavo USB Type-C per la ricarica; caricabatterie non incluso.

Sister Light mini is a rechargeable battery-powered cordless table lamp. A "touch" control on the head allows switching on/off, dimming (4-step: 100%, 60%, 30%, 6%) and selecting the color temperature of the light (2700K, 3150K or 4000K). It is suitable for both indoor and outdoor use and salt spray resistant (1500 h). The head of the lamp comes screwed to the stem; it can be converted to magnetic fixing and detached to become an emergency light. The base of the lamp is designed to be mechanically fixed to a table. An electronic control system monitors the remaining autonomy and ensures a constant luminous flux until the battery runs out. Recharging is therefore optimized and always properly done. The lamp comes with a USB Type-C cable per recharging; the battery charger is not included.

Sister Light mini table lamp  
gold → LD030603

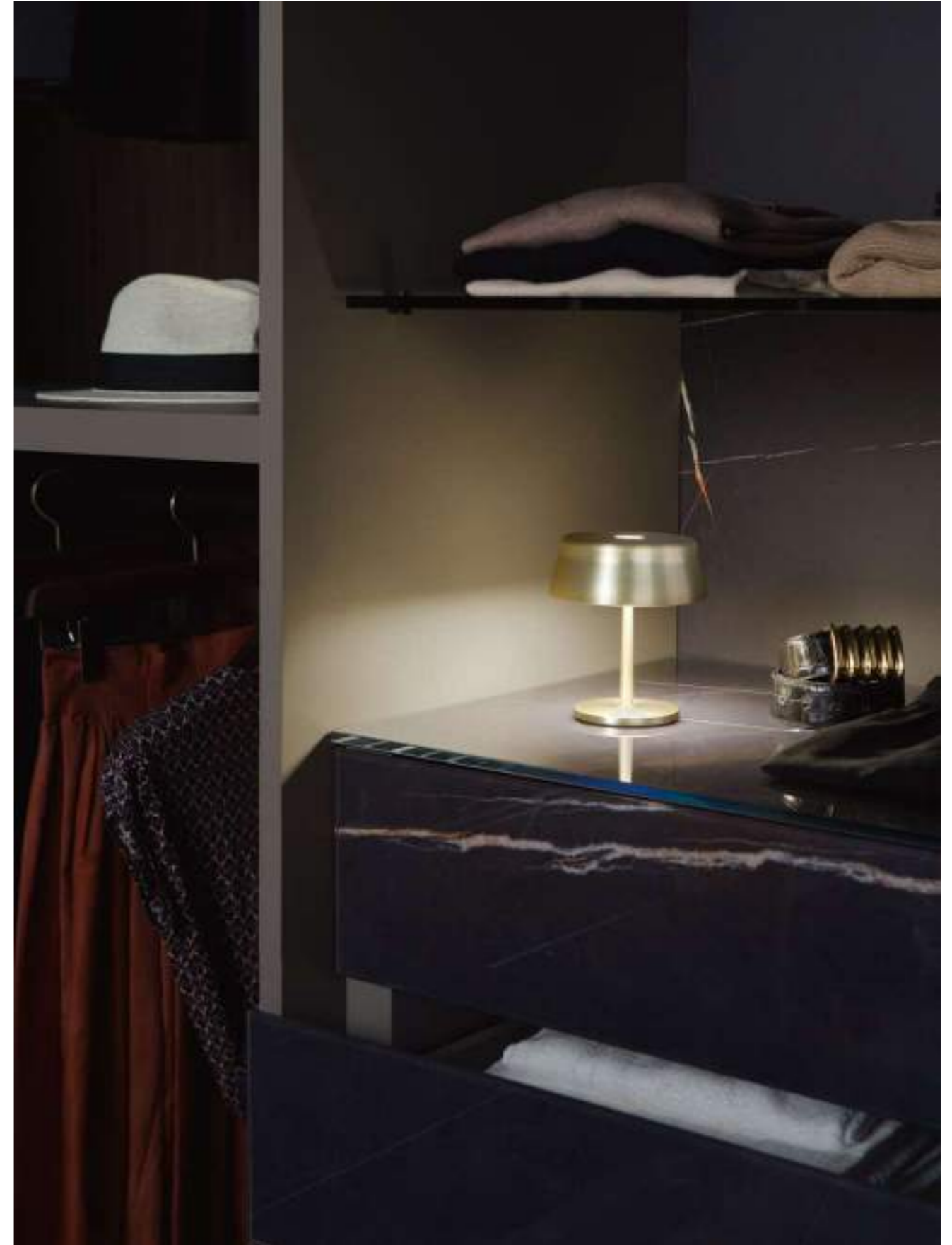



**Dati tecnici**

## Technical data

LED TOUCH DIMMER | 2700-3150-4000K | CRI>90 | 3W | 305-326-328lm |  
**IP65** | 5 Vdc max 2A



Corpo in alluminio anodizzato spazzolato  
 Brushed anodized aluminum body

Diffusore in policarbonato prismatico  
 Prismatic polycarbonate diffuser

Adatta all'uso esterno (lampada IP65) e interno (lampada su base di ricarica IP20) → legenda pag. 208  
 Suitable for outdoor (lamp IP65) and indoor use (lamp on charging base IP20) → legend pg. 208

Resistenza agli urti (IK07) e alla nebbia salina (1500h)  
 Impact resistance (IK07) and salt spray resistance (1500h)

Durata 8 - 58 h, in base alla regolazione del flusso luminoso  
 Battery lasts 8 - 58 h, depending on the luminous flux setting.

Tempo di ricarica a 2A: circa 5 h  
 Charging time at 2A: about 5 h

Ricarica con cavetto USB-c  
 Rechargeable with a USB-c cable

Pacco batteria al litio ricaricabile e sostituibile  
 Rechargeable and replaceable lithium battery pack

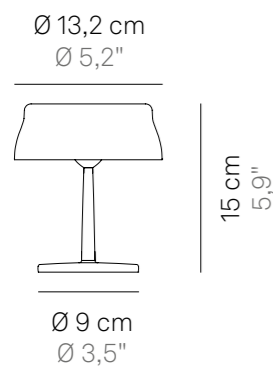
**Componenti inclusi**

## Components included

Cavo di ricarica con entrata USB-c  
 Charging cable with USB-c input

Kit per fissaggio magnetico  
 Kit for magnetic fixing

Kit per fissaggio meccanico al tavolo  
 Kit for mechanical fixing to a table

**Componente non incluso**

## Component not included

Caricabatterie 5Vdc max 2,1A \* → pag. 199  
 Charger 5Vdc max 2,1A \* → pg. 199

\* Componente necessario, da acquistare separatamente  
 \* Necessary component, yet it must be purchased separately

**Finiture**

## Finishes



**LD030603**  
 Oro / Gold



**LD0306R3**  
 Rame / Copper



**LD0306V3**  
 Verde / Green



Sister Light mini table  
 lamp gold → **LD030603**  
 Hotel Venice Venice  
 Venezia, Italy



# Sister Light

## Picchetto

Lamp with peg



Sister Light è una lampada a batteria, portatile e ricaricabile con picchetto. Nella parte superiore della testa è presente un controllo "touch" che permette l'accensione, la regolazione dell'intensità luminosa (dimmerazione a 4 step) e la selezione della temperatura di colore della luce tra 2700K, 3150K e 4000K. Grazie a un alto indice di protezione, la lampada è utilizzabile anche all'esterno; resiste inoltre alla nebbia salina (1500 h). La testa della lampada, calamitata sullo stelo (convertibile a fissaggio meccanico) può essere separata per diventare una fonte luminosa di emergenza. La lampada è fornita con un kit di elementi che permette di configurarne l'altezza in tre misure: 56, 81 o 106 cm. Possiede un sistema di controllo elettronico che monitora l'autonomia residua e garantisce un flusso luminoso costante fino all'esaurimento della batteria, permettendo di ottimizzare le ricariche ed effettuarle sempre in maniera corretta. È dotata di cavo USB Type-C per la ricarica; caricabatterie non incluso.

Sister Light is a rechargeable battery-powered cordless lamp with peg. A "touch" control on the head allows switching on/off, dimming (4-step: 100%, 60%, 30%, 6%) and selecting the color temperature of the light (2700K, 3150K or 4000K). It is suitable for both indoor and outdoor use and salt spray resistant (1500 h). The head of the lamp comes screwed to the stem; it can be converted to magnetic fixing and detached to become an emergency light. It is provided with a 3-rod kit that allows to choose the height of the lamp among 56, 81 or 106 cm. An electronic control system monitors the remaining autonomy and ensures a constant luminous flux until the battery runs out. Recharging is therefore optimized and always properly done. The lamp comes with a USB Type-C cable per recharging; the battery charger is not included.

Sister Light lamp with peg green → **LD0302V3**  
Sister Light lamp with peg copper → **LD0302R3**





**Dati tecnici**

## Technical data

LED TOUCH DIMMER | 2700-3150-  
4000K | CRI>90 | 3W | 305-326-328lm |  
**IP65** | 5 Vdc max 2A

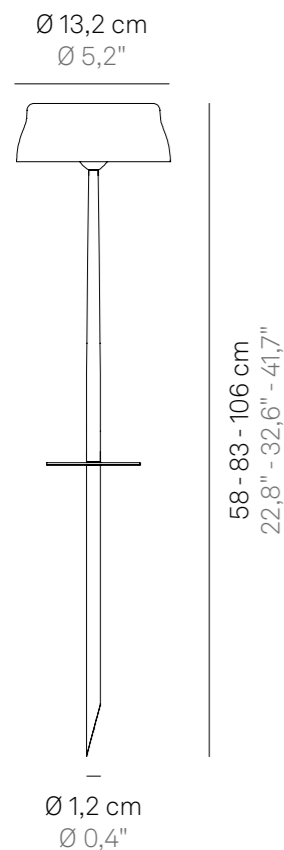

25 cm  
9,8"

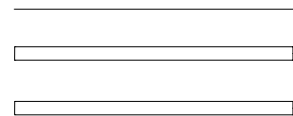
**Componenti inclusi**

## Components included

Cavo di ricarica con entrata USB-c  
Charging cable with USB-c input

Kit per fissaggio magnetico  
Kit for magnetic fixin

Stelo (2 pz.)  
Stem (2 pcs.)

Corpo in alluminio anodizzato spazzolato  
Brushed anodized aluminum body

Diffusore in policarbonato prismatico  
Prismatic polycarbonate diffuser

Adatta all'uso esterno (lampada IP65) e interno  
(lampada su base di ricarica IP20) → legenda pag. 208  
Suitable for outdoor (lamp IP65) and indoor use  
(lamp on charging base IP20) → legend pg. 208

Resistenza agli urti (IK07) e alla nebbia salina (1500h)  
Impact resistance (IK07) and salt spray resistance  
(1500h)

Durata 8 - 58 h, in base alla regolazione del flusso  
luminoso  
Battery lasts 8 - 58 h, depending on the luminous  
flux setting.

Tempo di ricarica a 2A: circa 5 h  
Charging time at 2A: about 5 h

Ricarica con cavetto USB-c  
Rechargeable with a USB-c cable

Pacco batteria al litio ricaricabile e sostituibile  
Rechargeable and replaceable lithium battery pack

**Avvertenze**

## Remarks

La testa della lampada può essere svitata per  
avvicinarla a una fonte di alimentazione, facilitando  
l'operazione di ricarica.

The head can be removed from the body of the lamp  
for easier recharging.

**Componente non incluso**

## Component not included

Caricabatterie 5Vdc max 2,1A \* → pag. 199  
Charger 5Vdc max 2,1A \* → pg. 199

\* Componente necessario, da acquistare separatamente

\* Necessary component, yet it must be purchased separately

**Finiture**

## Finishes



**LD0302R3**  
Rame / Copper

**LD0302V3**  
Verde / Green

# Sister Light

## Parete Wall lamp



Sister Light wall lamp  
copper → **LD0308R3**

Sister Light parete è una lampada a batteria, portatile e ricaricabile. Nella parte superiore della testa è presente un controllo "touch" che permette l'accensione, la regolazione dell'intensità luminosa (dimmerazione a 4 step) e la selezione della temperatura di colore della luce tra 2700K, 3150K e 4000K. Grazie a un alto indice di protezione, la lampada è utilizzabile anche all'esterno; resiste inoltre alla nebbia salina (1500 h). La testa della lampada, calamitata sul braccio (convertibile a fissaggio meccanico) può essere separata per diventare una fonte luminosa di emergenza. Possiede un sistema di controllo elettronico che monitora l'autonomia residua e garantisce un flusso luminoso costante fino all'esaurimento della batteria, permettendo di ottimizzare le ricariche ed effettuarle sempre in maniera corretta. È dotata di cavo USB Type-C per la ricarica; caricabatterie non incluso.

Sister Light is a rechargeable battery-powered cordless wall lamp. A "touch" control on the head allows switching on/off, dimming (4-step: 100%, 60%, 30%, 6%) and selecting the color temperature of the light (2700K, 3150K or 4000K). It is suitable for both indoor and outdoor use and salt spray resistant (1500 h). The head of the lamp is magnetically attached to the arm; it can be detached to become an emergency light. The fixing kit can be converted from magnetic to mechanical. An electronic control system monitors the remaining autonomy and ensures a constant luminous flux until the battery runs out. Recharging is therefore optimized and always properly done. The lamp comes with a USB Type-C cable per recharging; the battery charger is not included.





**Dati tecnici**

## Technical data

LED TOUCH DIMMER | 2700-3150-4000K | CRI>90 | 3W | 305-326-328lm |  
**IP65** | 5 Vdc max 2A

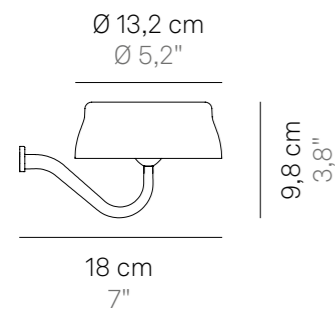

Corpo in alluminio anodizzato spazzolato  
 Brushed anodized aluminum body

Diffusore in policarbonato prismatico  
 Prismatic polycarbonate diffuser

Adatta all'uso esterno (lampada IP65) e interno (lampada su base di ricarica IP20) → legenda pag. 208  
 Suitable for outdoor (lamp IP65) and indoor use (lamp on charging base IP20) → legend pg. 208

Resistenza agli urti (IK07) e alla nebbia salina (1500h)  
 Impact resistance (IK07) and salt spray resistance (1500h)

Durata 8 - 58 h, in base alla regolazione del flusso luminoso  
 Battery lasts 8 - 58 h, depending on the luminous flux setting.

Tempo di ricarica a 2A: circa 5 h  
 Charging time at 2A: about 5 h

Ricarica con cavetto USB-c  
 Rechargeable with a USB-c cable

Pacco batteria al litio ricaricabile e sostituibile  
 Rechargeable and replaceable lithium battery pack

**Avvertenze**

## Remarks

La testa della lampada può essere svitata per avvicinarla a una fonte di alimentazione, facilitando l'operazione di ricarica.  
 The head can be removed from the body of the lamp for easier recharging.

**Componenti inclusi**

## Components included

Cavo di ricarica con entrata USB-c  
 Charging cable with USB-c input

Kit per fissaggio magnetico  
 Kit for magnetic fixing

**Componente non incluso**

## Component not included

Caricabatterie 5Vdc max 2,1A \* → pag. 199  
 Charger 5Vdc max 2,1A \* → pg. 199

\* Componente necessario, da acquistare separatamente

\* Necessary component, yet it must be purchased separately

**Finiture**

## Finishes

**LD0308R3**

Rame / Copper

**LD0308V3**

Verde / Green



Sister Light wall lamp  
 green → **LD0308V3**

# Pencil

Design Federico de Majo

Sospesa magicamente  
abbracciata o libera  
sembri sostenere il peso del tronco.  
Esile presenza  
ti presti a giocare  
in una luminosa danza.

Magically suspended  
embraced or free  
you appear to be bearing the weight of a trunk.  
Slender presence  
you play along  
in a luminous dance.

MODULO LUCE / CARICABATTERIE / BASE DI STAZIONAMENTO E RICARICA / BASE DI STAZIONAMENTO ROTANTE / SUPPORTI TAVOLO /  
SUPPORTI PARETE ORIZZONTALE / SUPPORTO PARETE VERTICALE / SUPPORTO SOSPENSIONE VERTICALE / SUPPORTI SOSPENSIONE  
ORIZZONTALE LIGHTING MODULE / BATTERY CHARGER / DOCKING AND CHARGING STATION / ROTATING DOCKING STATION / TABLE BASES  
/ HORIZONTAL WALL LAMP BRACKETS / VERTICAL WALL LAMP KIT / VERTICAL SUSPENSION KIT / HORIZONTAL SUSPENSION KIT



Pencil lighting module large white → **LD0802B3**  
Pencil lighting module medium white → **LD0801B3**  
Pencil lighting module small white → **LD0800B3**  
Cansiglio forest  
Treviso, Italy





Progetto selezionato dall'Osservatorio Permanente del Design ADI per ADI Design Index 2022.

Project selected by the ADI Permanent Design Observatory for ADI Design Index 2022.

Pencil è un sistema di illuminazione composto da un modulo luminoso a batteria portatile e ricaricabile e dagli accessori dedicati che lo trasformano in lampada da terra, tavolo, parete e a sospensione. Il modulo Pencil può dunque usato nel suo alloggiamento fisso, ma anche rimosso, portato con sé da un ambiente all'altro, e usato autonomamente: continuerà a funzionare a lungo, fino all'esaurimento della carica accumulata (fino a 58 ore). La sorgente a LED produce una luce intensa e ben direzionata, che grazie alla dimmerazione a 4 step e alla funzione di selezione della temperatura di colore consente di calibrare con precisione l'illuminazione di spazi pubblici e privati, anche outdoor.

Pencil is a lighting system consisting of a rechargeable battery-powered cordless light module, and the dedicated accessories that transform it into a wall, pendant, and floor/table lamp. The module can therefore be used in its fixed housing, but also removed and carried from one place to another, and used independently: it will continue to function for a long time, until the accumulated charge power runs out (up to 58 h). The LED source produces a bright, well-directed light, which - thanks to the 4-step dimming and the color temperature selection functions - provides the most appropriate illumination for public and private spaces, also outdoors.

Pencil lighting module medium  
corten → **LD0801R3**  
Glamping Canonici, Venice



# Pencil

## Modulo luce Lighting module



Video Pencil



Pencil è un modulo luminoso a batteria, portatile e ricaricabile, disponibile in tre misure. All'estremità del modulo è presente un controllo "touch", che permette l'accensione, la regolazione dell'intensità luminosa (dimmerazione a 4 step) e la selezione della temperatura di colore della luce tra 2700K, 3150K e 4000K. Grazie a un alto indice di protezione, il modulo luminoso è utilizzabile anche all'esterno; resiste inoltre alla nebbia salina (1500 h). Possiede un sistema di controllo elettronico che monitora l'autonomia residua e garantisce un flusso luminoso costante fino all'esaurimento della batteria, permettendo di ottimizzare le ricariche ed effettuarle sempre in maniera corretta. Il modulo Pencil può essere ricaricato in due modi: direttamente tramite caricabatterie (pag. 182); o a contatto sulla base di stazionamento, la quale può essere utilizzata anche solo come alloggio del modulo, per un utilizzo come lampada da terra o da tavolo (pag. 184). Caricabatterie non incluso.

Pencil is a battery-operated portable and rechargeable lighting module, available in three sizes. A "touch" control on one end allows switching on/off, dimming (4-step: 100%, 60%, 30%, 6%) and selecting the color temperature of the light (2700K, 3150K or 4000K). It is suitable for both indoor and outdoor use and salt spray resistant (1500 h). An electronic control system monitors the remaining autonomy and ensures a constant luminous flux until the battery runs out. Recharging is therefore optimized and always properly done. The lighting module can be recharged in two ways: either with the battery charger (pg. 182) or in the docking station, connected to a battery charger (pg. 184). The battery charger is not included.

Pencil lighting module medium white  
+ vertical suspension kit  
→ LD0801B3 + LD0811B3

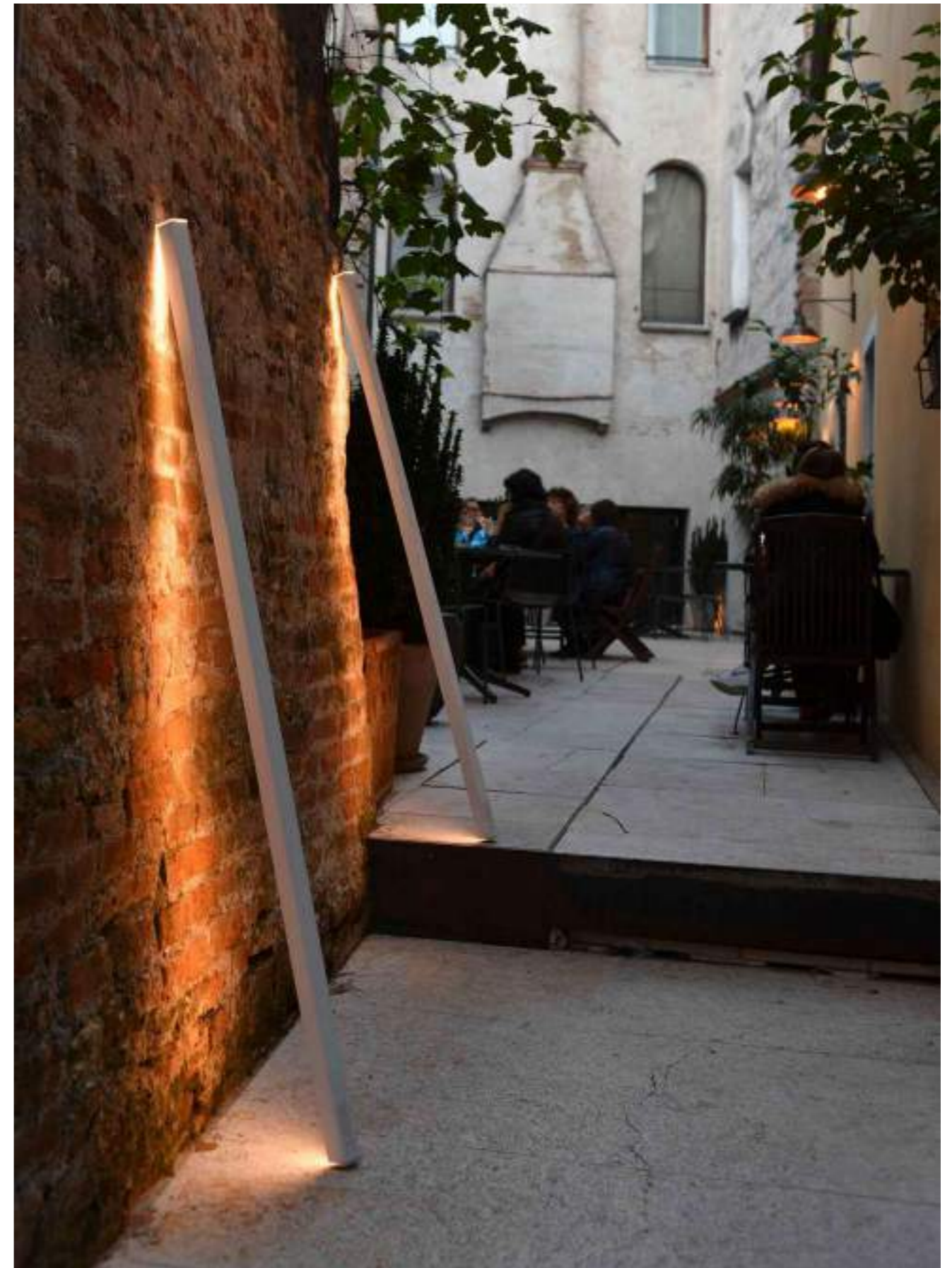



## Dati tecnici

## Technical data

LED TOUCH DIMMER | 2700-3150-4000K | CRI>90 | 6W | 580-650-680lm | **IP65** | 19 Vdc max 2,5 A

LED TOUCH DIMMER | 2700-3150-4000K | CRI>90 | 12W | 1160-1300-1360lm | **IP65** | 19 Vdc max 2,5 A

LED TOUCH DIMMER | 2700-3150-4000K | CRI>90 | 18W | 1740-1950-2040lm | **IP65** | 19 Vdc max 2,5 A

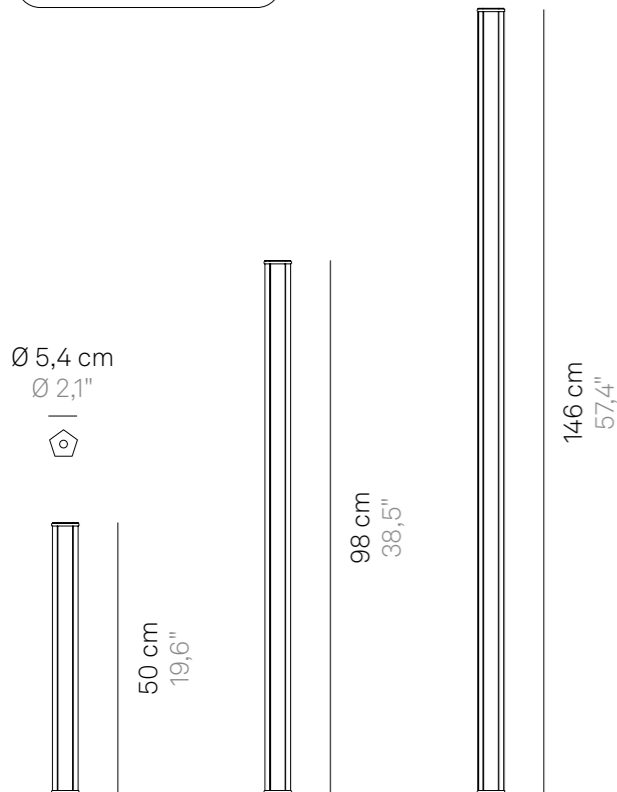

Pacchi batterie al litio ricaricabili e sostituibili  
Rechargeable and replaceable lithium battery packs

Durata 8 - 58 h, in base alla regolazione del flusso luminoso

Battery lasts 8 - 58 h, depending on the luminous flux setting.

Ricarica con connettore 3.5/1.3, oppure a contatto (quando usato su base ricarica)

Rechargeable with a 3.5/1.3 connector, or by contact (when used with the charging base)

Tempi di ricarica a 3,16A: 6/9/12 h (rispettivamente per misura piccola/media/grande)

Recharging times at 3.16A: 6/9/12 h (for small/medium/ large size respectively)

Corpo in estrusione d'alluminio verniciato  
Painted extruded aluminum fixture

Diffusore in policarbonato opale satinato  
Satin opal polycarbonate diffuser

Adatta all'uso esterno (lampada IP65) e interno (lampada su base di ricarica IP20) → legenda pag. 208

Suitable for outdoor (lamp IP65) and indoor use (lamp on charging base IP20) → legend pg. 208

Resistenza agli urti (IK07) e alla nebbia salina (1500h)  
Impact resistance (IK07) and salt spray resistance (1500h)

## Avvertenze

## Remarks

Con gli accessori dedicati, il modulo luminoso Pencil può diventare lampada da terra, tavolo, parete e a sospensione.

Thanks to its dedicated accessories, the lighting module can become a floor, table, wall and pendant lamp.

## Componente non incluso

## Component not included

Caricabatterie 19Vdc max 2,5A → pag. 182  
Charger 19Vdc max 2,5A → pg. 182

\* Componente necessario, da acquistare separatamente  
\* Necessary accessory, yet it must be purchased separately

## Finiture

## Finishes



Bianco  
/ White  
RAL 9003

Corten

Grigio scuro  
/ Dark grey  
RAL 7012

## Small

**LD0800B3**

**LD0800R3**

**LD0800G3**

## Medium

**LD0801B3**

**LD0801R3**

**LD0801G3**

## Large

**LD0802B3**

**LD0802R3**

**LD0802G3**

## Completa la tua lampada

## Complete your lamp

Caricabatterie → pg. 182  
Battery charger → pg. 182

 Supporti parete orizzontale → pg. 190  
Horizontal wall lamp brackets → pg. 190

 Base di stazionamento e ricarica → pg. 184  
Docking and charging station → pg. 184

 Supporto parete verticale → pg. 192  
Vertical wall lamp kit → pg. 192

 Base di stazionamento rotante → pg. 186  
Rotating docking station → pg. 186

 Supporto sospensione verticale → pg. 194  
Vertical suspension kit → pg. 194

 Supporti tavolo → pg. 188  
Table bases → pg. 188

 Supporti sospensione orizzontale → pg. 196  
Horizontal suspension kit → pg. 196

# Pencil

## Caricabatterie Battery charger



LD0800CS

### Dati tecnici

#### Technical data

47,5W • 100-240V • 50-60Hz  
19Vdc max 2,5A

CE IP20

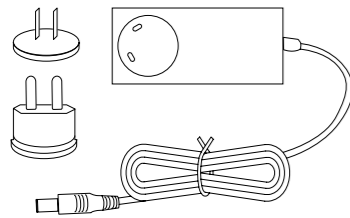

Il caricabatterie permette di ricaricare Pencil in due modi: collegando il cavo (fig. 1) direttamente al modulo luminoso; oppure collegando il cavo alla base di stazionamento e ricarica in cui il modulo viene posizionato (fig. 2). È un componente necessario, da acquistare separatamente: la lunga durata della batteria di Pencil consente infatti di utilizzare un solo caricabatterie per caricare più moduli. Ha una forma compatta, un cavo con attacco 3,5/1,3 e una spina intercambiabile per EU/USA in dotazione; funziona a 100-240V.

The battery charger allows the recharging of Pencil in two ways: either by connecting cable directly to the lighting module (fig. 1); or by connecting the cable to the docking station where the module is placed (fig. 2). It is a necessary accessory, yet it must be purchased separately: the long-lasting battery of Pencil enables to use just one battery charger to charge multiple lighting modules. It has a compact design, a cable with 3.5/1.3 connection and an interchangeable plug suitable for EU / USA standards; dual voltage 100-240V.





# Pencil

## Base di stazionamento e ricarica\*

Docking and charging station\*

\* Solo se connesso al caricatore

\* Only if connected with the charger



Pencil lighting module large white  
+ docking station white  
→ **LD0802B3 + LD0810B3**  
Osteria Stasera Corder - Treviso, Italy  
Photo phEsci Francesco Esci

### Dati tecnici

Technical data

19Vdc max 3,16A

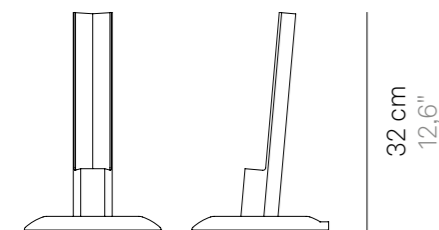

32 cm  
12,6"

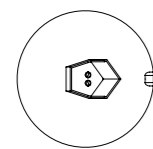

Ø 20 cm  
Ø 7,8"

### Finiture

Finishes



**LD0810B3**  
Bianco  
/ White  
RAL 9003



**LD0810R3**  
Corten



**LD0810G3**  
Grigio scuro  
/ Dark grey  
RAL 7012

Corpo in alluminio verniciato  
Painted aluminum fixture

**Componente non incluso**  
Component not included

Caricabatterie → pag. 182  
Charger → pg. 182

Accessorio con doppia funzione: è principalmente una base di stazionamento, che trasforma Pencil (pag. 178) in lampada da terra o da tavolo; collegato al caricabatterie, diventa una base di ricarica a contatto per il modulo luminoso. Il modulo luminoso può essere usato nel suo alloggiamento fisso, ma anche rimosso e portato con sé da un ambiente all'altro.

A dual-function accessory: it is mainly used as a docking station, turning the lighting module Pencil (pg. 178) into a floor or table lamp. Connected to the battery charger, it becomes a contact charging base for the lighting module. The lighting module can be used in its fixed housing, or detached and carried from one place to another.



# Pencil

## Base di stazionamento rotante\*

Rotating docking station\*

\* Non assolve la funzione di ricarica

\* Not a charging station



### Dati tecnici

Technical data

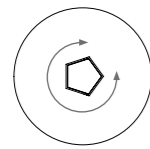
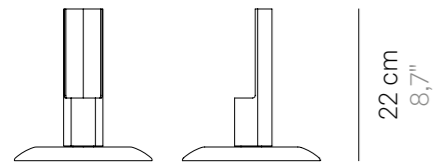

Ø 20 cm  
Ø 7,8"

### Finiture

Finishes



**LD0816B3**  
Bianco  
/ White  
RAL 9003



**LD0816R3**  
Corten



**LD0816G3**  
Grigio scuro  
/ Dark grey  
RAL 7012

Corpo in alluminio verniciato  
Painted aluminum fixture

Base di stazionamento che trasforma Pencil (pag. 178) in lampada da terra o da tavolo. Questo accessorio mantiene il modulo luminoso in posizione perpendicolare rispetto al piano di appoggio, e ne permette la rotazione a 360° sull'asse longitudinale, in entrambi i sensi. Il modulo luminoso può essere usato nel suo alloggiamento fisso, ma anche rimosso e portato con sé da un ambiente all'altro. Questa base di stazionamento non assolve la funzione di ricarica.

A docking station that turns Pencil (pg. 178) into a floor lamp or table lamp. This accessory keeps the lighting module in a perpendicular position in relation to the supporting surface, thereby allowing it to rotate 360° on the longitudinal axis, in both directions. The lighting module can be used in its fixed housing or detached and carried from one place to another. This docking station does not charge the lamp.





# Pencil

## Supporti tavolo Table bases



### Dati tecnici Technical data

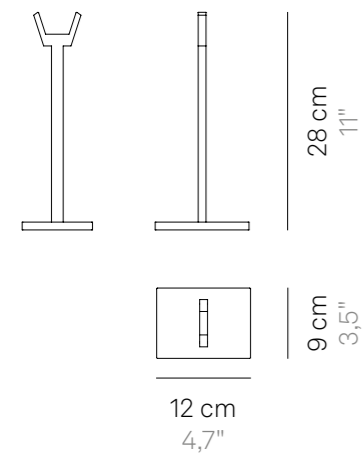

### Finiture Finishes



**LD081400**  
Trasparente / Transparent

Supporti in PMMA trasparente  
Transparent PMMA structure

Elementi che trasformano Pencil (pag. 178) in una lampada da tavolo. Il modulo luminoso può essere usato nel suo supporto, ma anche rimosso e portato con sé da un ambiente all'altro.

Elements that turn Pencil (pg. 178) into a table lamp.  
The lighting module can be used in its fixed housing or detached and carried from one place to another.



Pencil lighting module small white  
+ table bases  
→ LD0800B3 + LD081400

# Pencil

## Supporti parete orizzontale Horizontal wall lamp brackets



### Dati tecnici Technical data

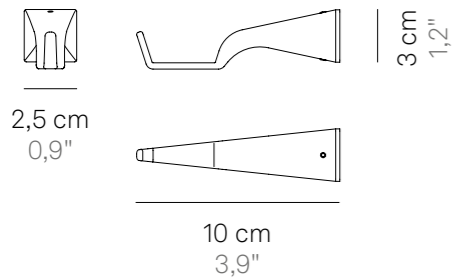

### Finiture Finishes



**LD0813B3**  
Bianco  
/ White  
RAL 9003

**LD0813R3**  
Corten

**LD0813G3**  
Grigio scuro  
/ Dark grey  
RAL 7012

Supporti in pressofusione d'alluminio verniciato  
Painted die-cast aluminum elements



Pencil lighting module small white  
+ horizontal wall lamp brackets white  
→ **LD0800B3 + LD0813B3**

Supporti che trasformano Pencil (pag. 178) in una lampada da parete orizzontale. Il modulo luminoso può essere usato nel suo supporto fisso, ma anche rimosso e portato con sé da un ambiente all'altro.

Brackets that turn Pencil (pg. 178) into a horizontal wall lamp. The lighting module can be used in its fixed housing or detached and carried from one place to another.



# Pencil

## Supporto parete verticale Vertical wall lamp kit



### Dati tecnici Technical data

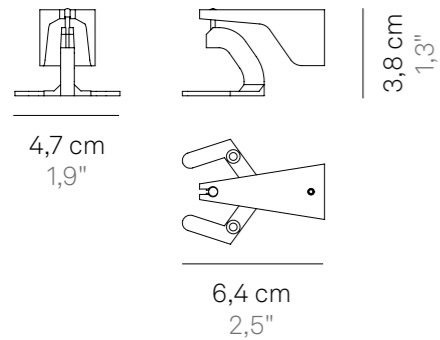

### Finiture Finishes



**LD0815B3**  
Bianco  
/ White  
RAL 9003



**LD0815R3**  
Corten



**LD0815G3**  
Grigio scuro  
/ Dark grey  
RAL 7012

Supporto in pressofusione d'alluminio  
verniciato con particolari cromati  
Painted die-cast aluminum element with  
chromed details

Elemento che trasforma Pencil (pag. 178) in una lampada da parete verticale, che ruota sul proprio asse longitudinale a 360°, in entrambi i sensi. Il modulo luminoso può essere usato nel suo supporto fisso, ma anche rimosso e portato con sé da un ambiente all'altro.

Element that turns Pencil (p. 178) into a vertical wall lamp, rotating on its longitudinal axis by 360°, in both directions. The lighting module can be used in its fixed housing or detached and carried from one place to another.



Pencil lighting module medium white  
+ vertical wall lamp kit white  
→ **LD0801B3** + **LD0815B3**

# Pencil

## Supporto sospensione verticale

Vertical suspension kit



### Dati tecnici

Technical data

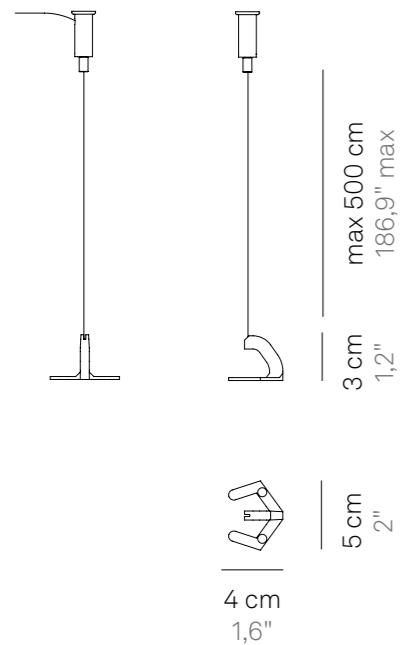

### Finiture

Finishes



**LD0811B3**  
Bianco  
/ White  
RAL 9003



**LD0811R3**  
Corten



**LD0811G3**  
Grigio scuro  
/ Dark grey  
RAL 7012

Supporto in pressofusione d'alluminio verniciato con particolari cromati  
Painted die-cast aluminum element with chromed details

**Componenti inclusi**  
Components included

Cavo in acciaio e staffe  
Steel cable and brackets

Elemento che trasforma Pencil (pag. 178) in una lampada a sospensione verticale. Il modulo luminoso può essere usato nel suo supporto fisso, ma anche rimosso e portato con sé da un ambiente all'altro.

Element that turns Pencil (pg. 178) into a vertical suspension lamp. The lighting module can be used in its fixed housing, or detached and carried from one place to another.



Pencil lighting module small dark grey  
+ vertical suspension kit dark grey  
→ **LD0800G3 + LD0811G3**



# Pencil

## Supporti sospensione orizzontale

Horizontal suspension kit



### Dati tecnici

Technical data

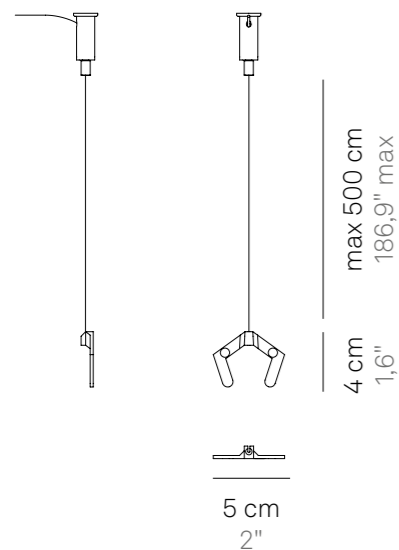

### Finiture

Finishes



**LD0812B3**  
Bianco  
/ White  
RAL 9003

**LD0812R3**  
Corten

**LD0812G3**  
Grigio scuro  
/ Dark grey  
RAL 7012

Supporto in pressofusione d'alluminio verniciato con particolari cromati  
Painted die-cast aluminum element with chromed details

**Componenti inclusi**  
Components included

Cavo in acciaio e staffe  
Steel cable and brackets

Elementi che trasformano Pencil (pag. 178) in una lampada a sospensione orizzontale a luce diretta. Il modulo luminoso può essere usato nel suo supporto fisso, ma anche rimosso e portato con sé da un ambiente all'altro.

Elements that turn Pencil (pg. 178) into a horizontal suspension lamp. The lighting module can be used in its fixed housing or detached and carried from one place to another.



Pencil lighting module medium dark grey  
+ horizontal suspension kit dark grey →  
**LD0801BG + LD0812G3**

# Accessori

## Accessories



LD0350RB  
Base di ricarica a contatto  
Contact charging base  
(Poldina, Poldina mini)



LD0490RB  
Base di ricarica a contatto  
Contact charging base  
(Poldina micro)



LD0395RB  
Base di ricarica a contatto  
Contact charging base  
(Poldina L desk)



LD0390RB  
Base di ricarica a contatto  
Contact charging base  
(Poldina L)



LD0800CS  
Caricabatterie con connettore  
3.5/1.3 (pag. 182)  
(Pencil modulo luce,  
Pencil base ricarica)  
Charger with a 3.5/1.3  
connector (page 182)  
(Pencil lighting module,  
Pencil charging base)  
  
48W  
INPUT: AC 100-240V | 50-60Hz  
OUTPUT: 19Vdc - max 2,5 A



LD0490UA  
Caricabatterie con entrata USB-a  
USB-a port power charger  
(Poldina micro, Swap mini,  
Push-up)  
  
INPUT: AC 100-240V | 50-60Hz  
OUTPUT: 5Vdc - max 1 A



LD0300UC  
Caricabatterie con doppia entrata  
USB-a e spina intercambiabile  
(EU/USA/UK)  
Dual USB-a port power charger  
and an interchangeable plug  
suitable for EU/USA/UK  
(Sister Light)  
  
INPUT: AC 100-240V | 50-60Hz  
OUTPUT: 5Vdc - max 2,1 A



CBL04200010000000  
Cavo di ricarica con entrata USB-c  
Charging cable with USB-c input  
(Sister Light)



LD0360RB  
Base di ricarica a contatto  
Contact charging base  
(Poldina XXL)



LD0850RB  
Base di ricarica a contatto  
Contact charging base  
(Olivia, Olivia mini)



LD0870RB  
Base di ricarica a contatto  
Contact charging base  
(Ofelia)

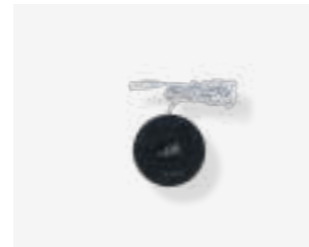

LD0688RB  
Base di ricarica a contatto  
(Poldina picchetto, Poldina  
sospensione, Poldina parete)  
Contact charging base  
(Poldina lamp with peg,  
Poldina suspension lamp,  
Poldina wall lamp)  
  
INPUT: AC 100-240V | 50-60Hz  
OUTPUT: 5Vdc max 1A



LD0340RA  
Caricatore multiplo 8 prese USB-a  
8 x USB-a ports multi charger  
  
40W  
INPUT: AC 100-240V | 50-60Hz  
OUTPUT: 5Vdc - max 8A (8 pcs.)



LD0350RP  
Base di ricarica a contatto  
multipla 6 posti  
Multi-contact charging base  
6 slots  
(Poldina, Poldina mini, Poldina  
Reverso, Pina, Swap, Swap  
mini, Push-up, Home, Dama,  
Olimpia)



LD0490RP  
Base di ricarica a contatto  
multipla 12 posti  
Multi-contact charging base  
12 slots  
(Poldina micro)



LD0870RP  
Base di ricarica a contatto  
multipla 6 posti  
Multi-contact charging base  
6 slots  
(Olivia, Olivia mini, Ofelia)



Base di ricarica a contatto  
Contact charging base  
LD0420RB (Poldina Reverso)  
LD0650RB (Pina)  
LD0610RB (Dama)  
LD0900RB (Olimpia)  
LD1010RB (Swap)  
LD0258RB (Home)



LD1011RB  
Base di ricarica a contatto  
Contact charging base  
(Swap mini)



LD1050RB  
Base di ricarica a contatto  
Contact charging base  
(Push-up)



LD0280UA  
Caricabatterie con entrata USB-a e  
cavo di ricarica con entrata USB-c  
Charger with USB-a input and  
charging cable with USB-c input  
  
INPUT: AC 100-240V | 50-60Hz  
OUTPUT: 5Vdc - max 1 A



LD0420V1  
Contenitore multiuso  
Multipurpose container tray  
(Poldina Reverso)



LD0300KT  
Kit per fissaggio meccanico  
al tavolo  
Kit for mechanical fixing  
to a table  
(Sister Light tavolo)



LD0300KN  
Kit per fissaggio magnetico  
(Sister Light)



LD0300KM  
Kit per fissaggio meccanico  
(Sister Light)



**Base di ricarica a contatto multipla (max 6 posti)**

Multi-contact charging base (max 6 slots)

→ Poldina, Poldina mini, Poldina Reverso, Pina, Swap, Swap mini, Push-up, Home, Dama, Olimpia



→ LD0350RP

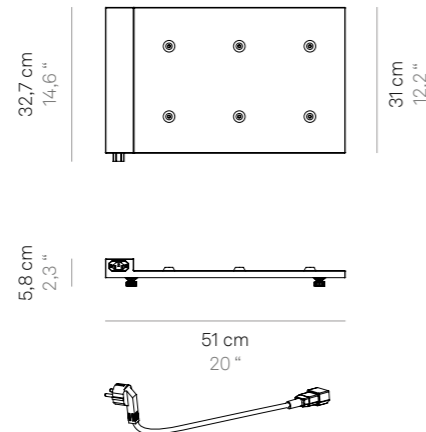

35W  
INPUT: AC 100-240V | 50-60Hz  
OUTPUT: 5Vdc max 6A

Base di ricarica a contatto multipla (max 6 posti) e modulare: più basi possono essere collegate in sequenza per caricare contemporaneamente più lampade. Particolarmente adatto all'uso professionale. Modular multi-contact (max 6 slots) charging base: they can be connected in sequence to simultaneously charge multiple set of lamps. Particularly suitable for professional use.

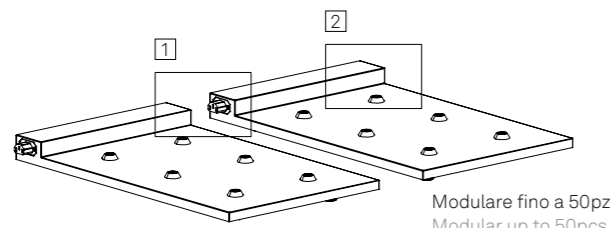
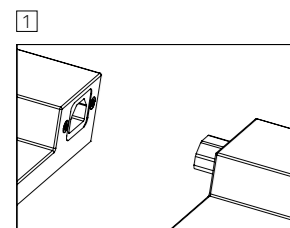

Modulare fino a 50pz  
Modular up to 50pcs

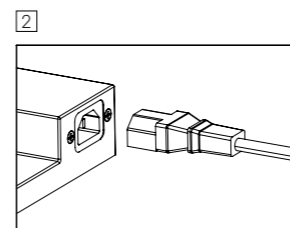
**Base di ricarica a contatto multipla (max 12 posti)**

Multi-contact charging base (max 12 slots)

→ Poldina micro



→ LD0490RP

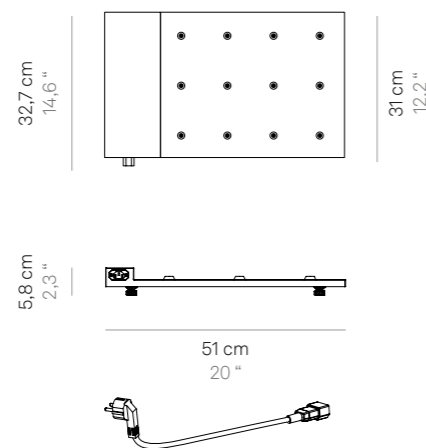

35W  
INPUT: AC 100-240V | 50-60Hz  
OUTPUT: 5Vdc max 12A

Base di ricarica a contatto multipla (max 12 posti) e modulare: più basi possono essere collegate in sequenza per caricare contemporaneamente più lampade. Particolarmente adatto all'uso professionale. Modular multi-contact (max 12 slots) charging base: they can be connected in sequence to simultaneously charge multiple set of lamps. Particularly suitable for professional use.

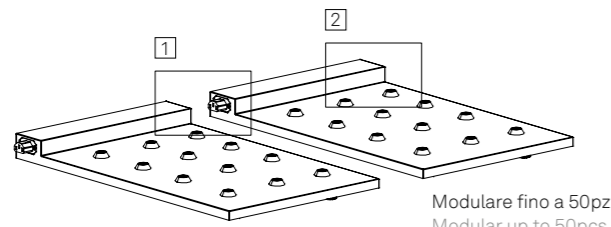
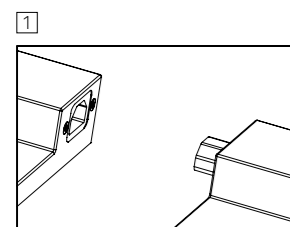

Modulare fino a 50pz  
Modular up to 50pcs

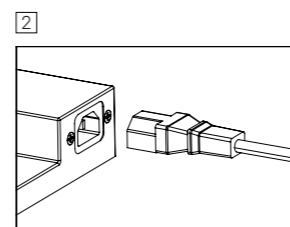
**Base di ricarica a contatto multipla (max 6 posti)**

Multi-contact charging base (max 6 slots)

→ Olivia, Olivia mini, Ofelia



→ LD0870RP

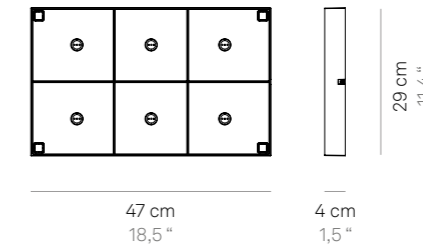

45W  
INPUT: AC 100-240V | 50-60Hz  
OUTPUT: 9Vdc max 5A

Base di ricarica a contatto multipla (max 6 posti) e modulare: più basi possono essere impilate (fino a max 3 livelli) per caricare contemporaneamente più lampade. Particolarmente adatto all'uso professionale. Modular multi-contact (max 6 slots) charging base: they can be stacked (up to max 3 levels) to simultaneously charge multiple set of lamps. Particularly suitable for professional use.

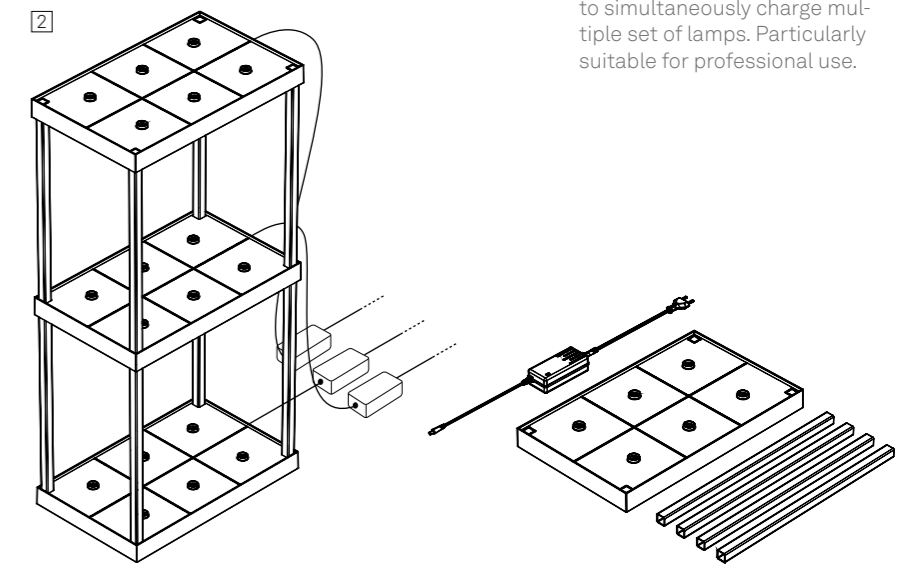
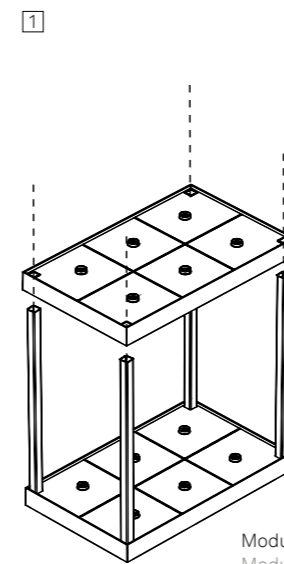

Modulare fino a 3 livelli.  
Modular up to 3 levels.

**Caricatore multiplo 8 prese USB**

8 x USB ports multi charger



→ LD0340RA

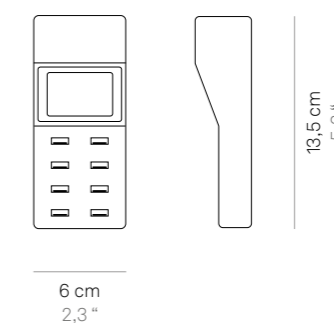

40W  
INPUT: AC 100-240V | 50-60Hz  
OUTPUT: 5Vdc - max 8A (8 pcs.)

Caricatore multipresa USB (8 x USB-A). Permette la carica di max 8 dispositivi contemporaneamente. Un display mostra graficamente il livello delle batterie in ricarica. Particolarmente adatto all'uso professionale. USB multi-socket charger (8 x USB-A). Can charge of up to 8 devices simultaneously. A graphic display shows the level of the batteries being charged. Particularly suitable for professional use.

## Batterie ricaricabili

### Rechargeable batteries

Le batterie ricaricabili sono soggette ad usura. La vita delle batterie, il cui standard è di circa 450 ricariche, può essere ridotta da alcuni fattori come: ① la modalità non corretta di ricarica (la lampada va ricaricata quando è scarica: circa il 10% della sua autonomia residua); ② lunghi periodi di stazionamento senza utilizzo; ③ lunghi periodi di stazionamento su base di ricarica in tensione anche se la lampada risulta carica; ④ l'utilizzo di accessori non originali per la ricarica; ⑤ l'esposizione del prodotto a temperature molto alte o molto fredde. Quando le lampade non si ricaricano più o l'autonomia risulta molto ridotta, le batterie devono essere sostituite. I ricambi delle lampade ricaricabili Zafferano sono disponibili a catalogo e identificati con apposito codice. La garanzia sulle batterie è valida solo per difetti di fabbricazione, che si manifestano al primo utilizzo.

All rechargeable batteries are subject to wear when used. The life of batteries, which can generally be recharged 450 times, may be reduced by certain factors: ① incorrect recharging mode (the lamp must be recharged when it is flat: about 10% of its remaining autonomy); ② when left unused for a long time; ③ when left for a long time on a live recharging base even if the lamp is recharged; ④ when non-original accessories are used for recharging; ⑤ when the product is exposed to very high or very low temperatures. When the lamps no longer recharge or their autonomy after recharging is very short, the batteries must be replaced. Spare parts for Zafferano rechargeable lamps can be found in the catalogue and identified by a special code. The warranty for batteries is only valid for manufacturing defects, if occurred at first use.

**BAT04701906701900** 3,7V | 1x2200mA/H  
Pacco batteria sostitutiva singola (necessari 2 pz., per **Pina tavolo, Push-up tavolo, Home tavolo**; necessari 3 pz., per **Poldina L desk tavolo, Poldina L terra-tavolo**)  
Single replacement battery pack (x2 pcs., needed for **Pina table lamp, Push-up table lamp, Home table lamp**; x 3 pcs., needed for **Poldina L desk table lamp, Poldina L floor-table lamp**)



**BAT04704004001000** 3,7V | 1x1900mA/H  
Pacco batteria sostitutiva singola (necessario 1 pz., per **Poldina micro tavolo**)  
Single replacement battery pack (1 pc., needed for **Poldina micro table lamp**)



**BAT04703706701900** 3,7V | 2x2200mA/H  
Pacco batteria sostitutiva doppia (necessario 1 pz., per **Poldina tavolo, Poldina mini tavolo, Poldina picchetto, Poldina sospensione, Poldina parete, Poldina Reverso tavolo, Olivia, Olivia mini, Ofelia, Dama, Olimpia**; necessari 3 pz., per **Poldina XXL terra-tavolo**)  
Double replacement battery pack (1 pc., needed for **Poldina table lamp, Poldina mini table lamp, Poldina lamp with peg, Poldina suspension lamp, Poldina wall lamp, Poldina Reverso table lamp, Olivia, Olivia mini table lamp, Ofelia, Dama, Olimpia**; 3 pcs., needed for **Poldina XXL floor-table lamp**)



**BAT04701906701902** 3,7V | 1x2600mA/H  
Pacco batteria sostitutiva singola (necessari 2 pz., per **Swap tavolo, Swap tavolo mini**)  
Single replacement battery pack (2 pcs., needed for **Swap table lamp, Swap mini table lamp**)



**BAT04705506701900** 3,7V | 7500mA/H  
Pacco batteria sostitutiva tripla (necessario 1 pz., per **Sister Light tavolo, Sister Light mini tavolo, Sister Light picchetto, Sister Light parete**)  
Triple replacement battery pack (x 1 pc., needed for **Sister Light table lamp, Sister Light mini table lamp, Sister Light lamp with peg, Sister Light wall lamp**)



**BAT04702719700300** 11,1V | 5000mA/H  
Pacco batteria sostitutiva per **modulo Pencil piccolo**  
Replacement battery pack for **small Pencil module**



**BAT04702739200600** 11,1V | 10000mA/H  
Pacco batteria sostitutiva per **modulo Pencil medio**  
Replacement battery pack for **medium Pencil module**



**BAT04702758700900** 11,1V | 15000mA/H  
Pacco batteria sostitutiva per **modulo Pencil grande**  
Replacement battery pack for **large Pencil module**



**Video tutorial:**  
sostituzione batterie  
**Tutorial video:**  
battery replacement



# Personalizzazione

## Customization

Su richiesta, con quantitativi minimi d'ordine, è possibile personalizzare le lampade con un servizio di logatura.

Available on request, with minimum ordering quantities, customised logo pad-printing service.



Punti personalizzabili  
Customizable spots

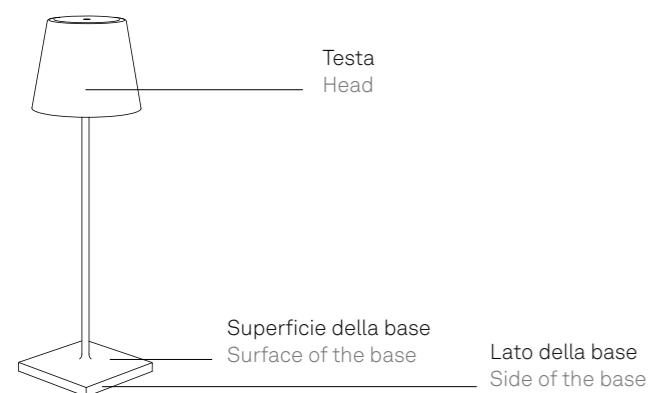

Bauli: logatura sul lato della base  
Bauli: customization on the side of the base  
(Poldina table lamp pro, LD0340P3)



Barilla: logatura sulla superficie della testa  
Barilla: customization on the surface of the head  
(Sister Light table lamp pro, LD030003 + LD0300R3)



Bulldog: logatura sulla testa  
Bulldog: customization on the head  
(Poldina micro table lamp pro, LD0490D3)



Logatura su cover in metallo, per modelli Poldina  
Customization on metallic cover, available for Poldina



Zafferano: logatura sulla superficie della base  
Zafferano: customization on the surface of the base  
(Poldina table lamp pro, LD0340B3)

# Espositore

## Display unit

Espositore per lampade portatili Zafferano, realizzato in cartone stampato a colori su tutti i lati. Sul ripiano è possibile esporre una lampada (vincolabile tramite un cavo di sicurezza), la sua base di ricarica e/o i cataloghi della collezione.

La parte inferiore a giorno permette di alloggiare fino a 28\* scatole di lampade portatili. Il basamento dell'espositore, realizzato in legno, è dotato di quattro ruote piroettanti (di cui le due posteriori con freno), che rendono agile lo spostamento e sicuro lo stazionamento dell'espositore.

\* Quantità riferita ai modelli da tavolo  
Poldina, Olivia, Ofelia, Pina

Display unit for Zafferano cordless lamps, made of solid cardboard printed in color on all sides. On the shelf, it is possible to display a lamp (which can be secured with a safety cable), its charging base and / or the catalogs of the collection. The open lower part accommodates up to 28\* boxes of portable lamps. The display unit base, made of wood, is equipped with four swiveling wheels (two rear ones with brakes), for easy moving and secure parking.

\* This quantity refers to table lamps  
Poldina, Olivia, Ofelia, Pina

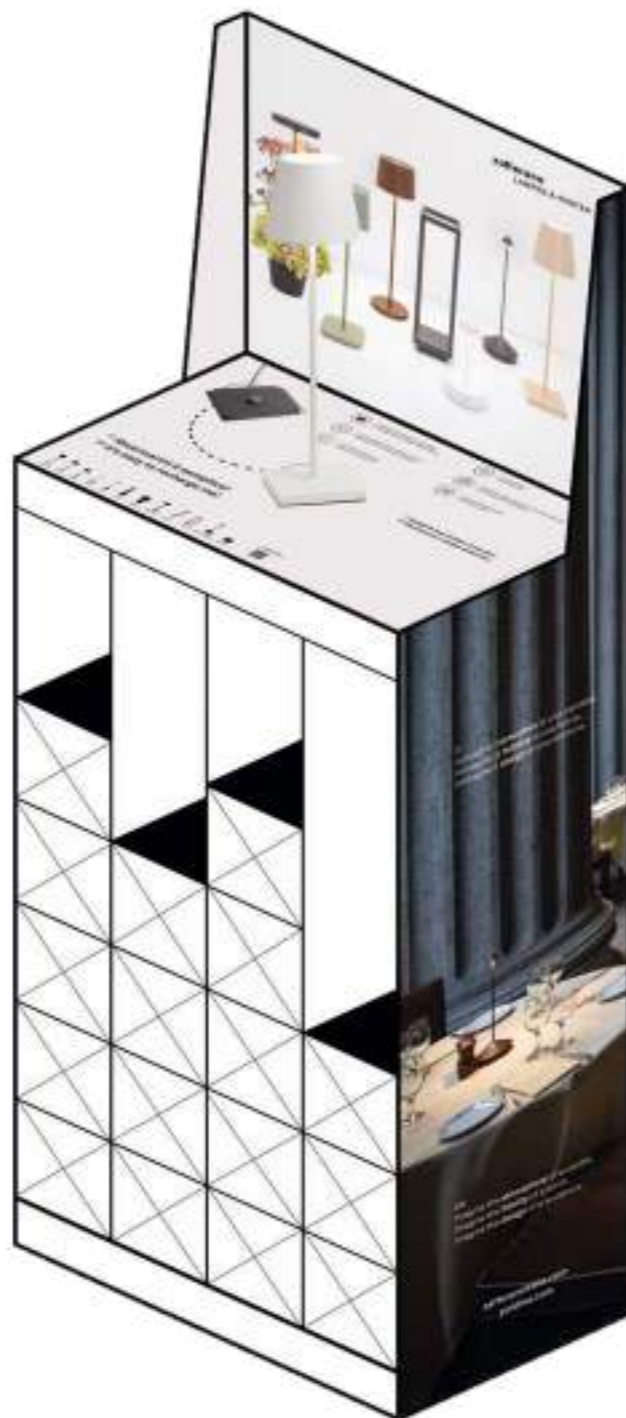

# Indice per codice

## Code index

LD0258B3 LD0258R3 LD0258N3	pg.139	LD0360B3 LD0360R3 LD0360N3	pg.41	LD0800B3 LD0800R3 LD0800G3 LD0801B3 LD0801R3 LD0801G3 LD0802B3 LD0802R3 LD0802G3	pg.181	LD1650B3 LD1650R3 LD1650N3 LD1650D3 LD1650S3 LD1650BFO LD1650BFA LD1650RFR	pg.97
LD0300O3 LD0300A3 LD0300R3 LD0300V3 LD0300B3	pg.161	LD0390B3 LD0390R3 LD0390N3	pg.37	LD0395B3 LD0395R3 LD0395N3	pg.33	LD1870B3 LD1870R3 LD1870N3 LD1870S3 LD1870G3	pg.77
LD0302R3 LD0302V3	pg.169	LD0420B3 LD0420R3 LD0420N3 LD0420S3 LD0420G3	pg.69	LD0850B3 LD0850R3 LD0850N3 LD0850BFO LD0850BFA LD0850RFR	pg.85		
LD0306O3 LD0306R3 LD0306V3	pg.165	LD0490B3 LD0490R3 LD0490N3 LD0490D3 LD0490S3 LD0490G3 LD0490P3 LD0490F3 LD0490K3 LD0490L3 LD0490V3 LD0490Z3 LD0490O3 LD0490C3	pg.28	LD0860B3 LD0860R3 LD0860N3 LD0860K3 LD0860L3 LD0860V3 LD0860Z3	pg.89		
LD0308R3 LD0308V3	pg.173	LD0900B3 LD0900N3 LD0900O3 LD0900C3 LD0900E3		LD1010B3 LD1010R3 LD1010N3	pg.153		
LD0320B3 LD0320R3 LD0320N3 LD0320S3 LD0320BFO LD0320BFA LD0320RFR LD0320O3 LD0320C3	pg.22	LD0610B3 LD0610N3	pg.147	LD1011B3 LD1011R3 LD1011N3 LD1011O3 LD1011C3 LD1011K3 LD1011L3 LD1011V3 LD1011Z3	pg.113		
LD0340B3 LD0340R3 LD0340N3 LD0340S3 LD0340G3 LD0340A3 LD0340P3 LD0340F3 LD0340X3 LD0340M3 LD0340O3 LD0340C3 LD0340BFO LD0340BFA LD0340RFR	pg.14	LD0682B3 LD0682R3 LD0682N3	pg.45	LD0686B3 LD0686R3 LD0686N3	pg.49		
LD0340FP1 LD0340BP2 LD0340BP3 LD0340BP4 LD0340RP5	pg.19	LD0688B3 LD0688R3 LD0688N3 LD0689B3 LD0689N3 LD0689R3	pg.53	LD1050B3 LD1050R3 LD1050N3 LD1050S3	pg.133		



**CE**  
 Dichiaro che il prodotto soddisfa gli standard dell'UE per la salute, la sicurezza e la protezione ambientale.  
 Declares that the product meets EU standards for health, safety, and environmental protection.



**CLASS II**  
 Apparecchio dotato di doppio isolamento e/o isolamento rinforzato in ogni parte e senza dispositivo di messa a terra.  
 Light fitting equipped with double isolation and/or isolation reinforced in every part and without earthing device.



**CLASS III**  
 Apparecchio basato su un'alimentazione a bassissima tensione di sicurezza, in cui non si producono tensioni superiori alla stessa.  
 Light fitting based on a very low safety voltage power supply, in which no tensions higher than the same are produced.



**IP PROTECTION DEGREE**  
 IP20: apparecchio protetto dalla penetrazione di corpi solidi di dimensioni maggiori a 12mm e non protetto dai liquidi.  
 IP54: apparecchio protetto da polveri e da spruzzi d'acqua.  
 IP65: apparecchio fortemente protetto da polveri e da getti d'acqua.  
 IP20: protected from the penetration of solid objects greater than 12 mm and non protected from liquids.  
 IP54: protected from dust and splashing water.  
 IP65: highly protected from dust and water jets.



**DIMMABLE**  
 Indica che è possibile regolare l'intensità luminosa della lampada.  
 Indicates that the light intensity of the lamp can be adjusted.

Headquarters  
**Zafferano SRL**  
 Viale dell'industria 26  
 31055 Quinto di Treviso (TV), Italy  
 T +39 0422 470507  
 F +39 0422 470400  
 vendite@zafferanoitalia.com

Subsidiary  
**Zafferano America LLC**  
 301 Penhorn Avenue  
 Suite 5,  
 Secaucus, NJ 07094  
 T +1 888 744 5277  
 info@zafferanoamerica.com

Showrooms  
**Zafferano Store Milano**  
 Via Fatebenefratelli, 23  
 Milan (Italy)  
**Zafferano Store Treviso**  
 Viale dell'Industria, 26  
 Quinto di Treviso (Italy)

Art Direction, Graphic Design  
 Zafferano Design

Photography  
 Claudio Mainardi  
 Alberto Sinigaglia  
 Quasar

Poems  
 Federico de Majo

©2023 Peanuts Worldwide LLC  
 www.peanuts.com

October 2023

Acknowledgements  
 Porto Caleri, Rovigo  
 Caglieron Caves, Treviso  
 Storga river springs, Treviso  
 Morgano countryside, Treviso  
 Piave riverbed, Treviso  
 Brent de l'Art, Belluno  
 Rosolina pine forest, Rovigo  
 Cansiglio forest, Treviso  
 Euganean hills, Padua (Italy)

Lago Design, Villa del Conte  
 Padua, Italy

L'azienda si riserva di apportare modifiche e/o migliorie di carattere tecnico ed estetico ai propri modelli e prodotti in qualsiasi momento e senza preavviso.  
 The company reserves the right to make modifications and improvements of a technical or aesthetic nature to the products at any time without notice.

Il prodotto è protetto da garanzia, a norma di legge.  
 The product is covered by a warranty, according to the law.

© Copyright Zafferano SRL

CATLAP23-10

zafferanoitalia.com  
 zafferanolampesaporter.com  
 zafferanoamerica.com  
 poldina.com

**zafferano**  
 LAMPES-À-PORTER